

Leistritz

LEISTRITZ PUMPEN GMBH

Leistritz Schraubenspindelpumpen & Systeme
Leistritz Screw Pumps & Systems

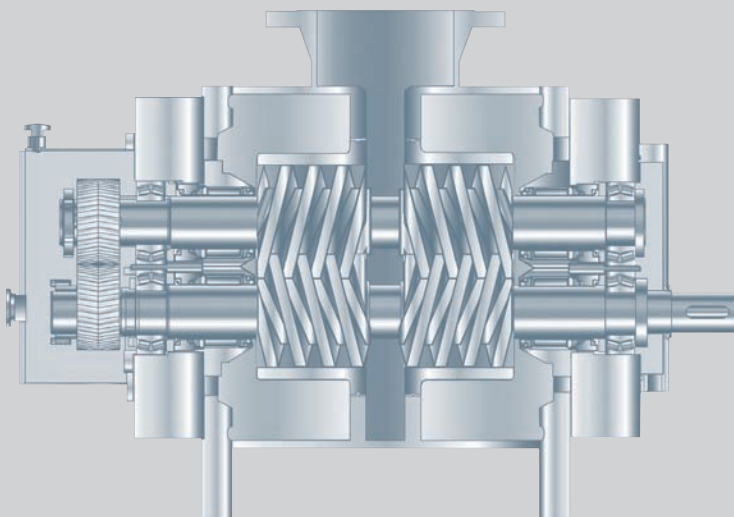
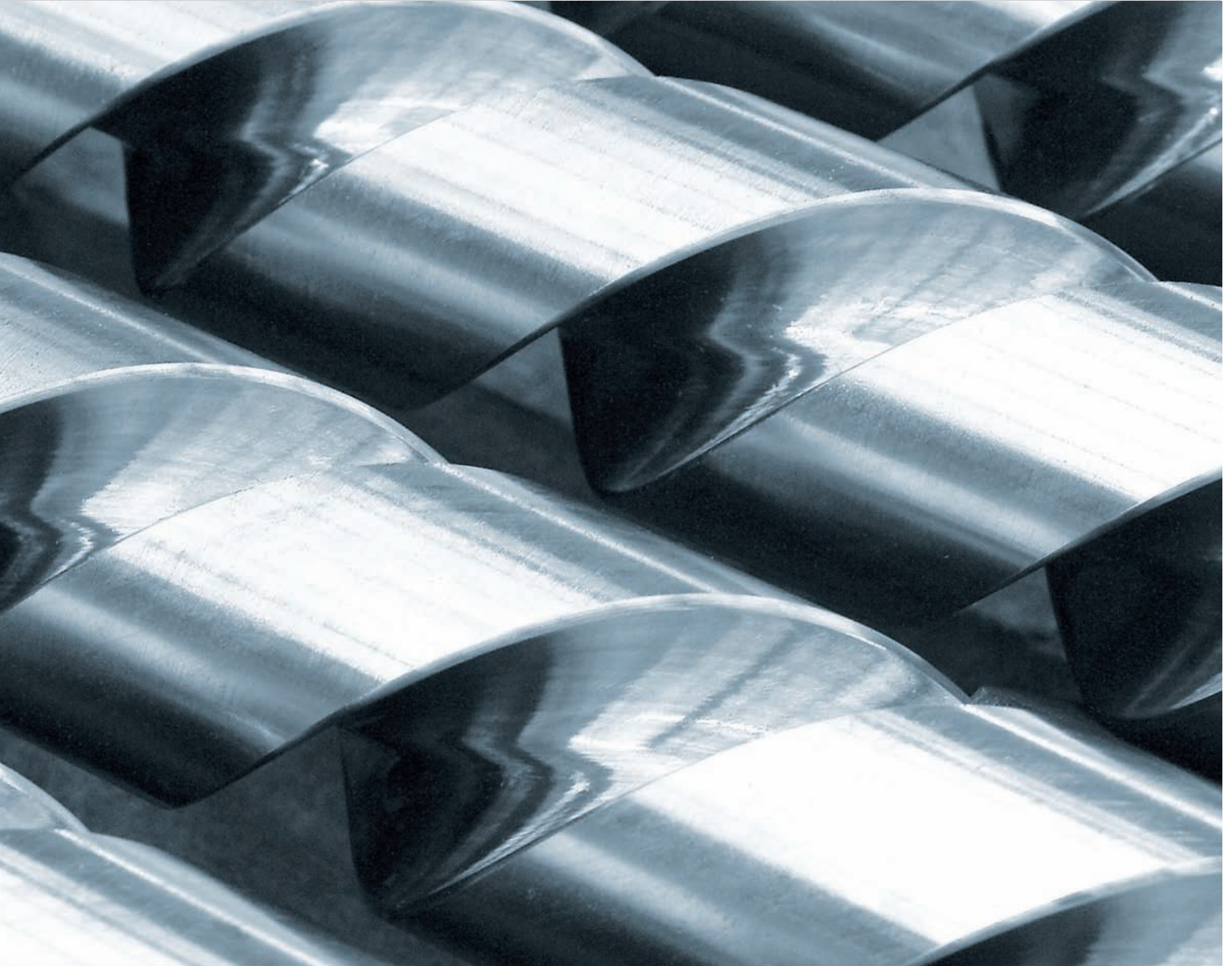

L4



L4

Inhalt/Content

Inhalt	Content	Seite/ Page
Allgemeine Verwendung	General Use	3
Einsatzgebiete	Applications	3
Bauform und Wirkungsweise	Design and Operation	3
Pulsation - Geräuschpegel	Pulsation - Noise level	4
Lagerung	Bearings	4
Wellenabdichtung	Shaft Seals	4
Druckbegrenzungsventil	Pressure Relief Valve	4
Wellenkupplung - Kupplungsschutz	Shaft Coupling - Coupling Guard	4
Einbau/Antrieb	Installation/Drive	5
Werkstoffe	Construction Materials	5
Einsatzgrenzen	Performance Data	5
Schnittzeichnung /Stückliste	Sectional Drawing /Parts List	6-7
Maßzeichnung L4	Dimensional Drawing L4	8
Maßblatt - Pumpe mit freiem Wellenende L4NG	Pump Dimension - Pump with bare Shaft End L4NG	9
Maßblatt - Pumpe mit freiem Wellenende L4MG	Pump Dimension - Pump with bare Shaft End L4MG	10
Maßblatt - Pumpe mit freiem Wellenende L4HG	Pump Dimension - Pump with bare Shaft End L4HG	11
Pumpen-Typenschlüssel und Bauform	Pump Type Code and Design	12-13
Kennfelder	Performance Characteristics	14-15
Baukastensystem	Modular System	16-17
Anwendungen	Applications	18-19

Pumpen Beschreibung / Pump Description

ALLGEMEINE VERWENDUNG

Leistritz Schraubenspindelpumpen der Baureihe L4 sind selbstansaugende, rotierende Verdrängerpumpen für Druckbereiche von 16 bar (232 psi), 40 bar (580 psi) und 150 bar (2175 psi). Sie dienen zur Förderung von schmierenden und nicht schmierenden, hoch- und niedrigviskosen Flüssigkeiten, auch mit leicht abrasiven Bestandteilen.

EINSATZGEBIETE

Öl & Gas

Verwendung als Pipelinepumpen, Pipeline Start-up Pumpen, Pumpen für Lagerstättenwasser, Pumpen für die Aufbereitung von Chemikalienzusätzen und Pumpen für Leckagesysteme auf Ölfeldern.

Tanklager

Verwendung als Be- und Entladepumpen, Zirkulationspumpen, Transferpumpen, Entleerungspumpen für Rohöle oder Fertigprodukte sowie Pumpen für die Tankreinigung.

Chemische und Petrochemische Industrie

Verwendung als Zirkulationspumpen, Transferpumpen, Entleerungspumpen, Exportpumpen zur Förderung niedrig und hochviskoser, reiner oder abrasiver, neutraler oder aggressiver Chemikalien sowie für Rohöl, Schmieröl und Heizöl, Teer, Bitumen, Asphalt, Fetten, Harzen und Rückständen.

Kraftwerkstechnik und Ölf Feuerungsanlagen

Verwendung als Entlade – und Transferpumpen zur Förderung von leichten und schweren Heizölen sowie zur Förderung von Altöl und Tankrückständen mit abrasiven Bestandteilen.

Schiffbau

Verwendung als Be- und Entladepumpen und Transferpumpen für aggressive und neutrale Roh – und Fertigprodukte mit hoher oder niedriger Viskosität.

BAUFORM UND WIRKUNGSWEISE

Selbstansaugende Schraubenspindel­pumpe mit zwei Spindeln in doppelflutiger und dadurch schubausgeglichener Ausführung. Das Drehmoment wird von der zweigängigen Antriebs­spindel mittels pfeilverzählter Zahnräder auf die ebenfalls zweigängigen Laufspindel übertragen. Die Spindeln laufen dichtkäm­mend aber berührungslos in der Spindelbohrung des auswechselbaren Pumpengehäuse­ein­satzes.

Durch die spezielle Profil­geometrie werden abgedichtete Kam­mern gebildet, die das Fördermedium kontinuierlich und ohne Quetschungen und Turbulenzen von beiden Saugseiten axial zum Druckraum transportieren.

Antriebs – und Laufspindel werden zur Erreichung einer hohen Festigkeit und geringer Durchbiegung aus einem Stück gefertigt.

GENERAL USE

Leistritz Screw Pumps , Series L4 are self-priming rotary positive displacement pumps for pressure ranges of 16 bar (232 psi), 40 bar (580 psi) and 150 bar (2175 psi) suitable for the transport of lubricating and non-lubricating, low and high viscous liquids with abrasive particles.

APPLICATIONS

Oil & Gas

Use as pipeline pumps, pipeline start-up pumps, produced water pumps, pumps for chemical injection and pumps for up-stream slop and drain systems.

Tank Storage

Use as loading/unloading pumps, circulation pumps, transfer pumps, stripping pumps and cargo pumps for crude oil and finished products, pumps for tank cleaning purposes.

Chemical and Petrochemical Industry

Use as circulation pumps, transfer pumps, stripping and export pumps for the transport of low and high viscous, clean or abra-sive, neutral or corrosive chemicals and for crude oil, fuel oil, lubricating oil, tar, bitumen, asphalt, fats, resins and residues.

Power Generation and Fuel Oil Systems

Use as unloading and transfer pumps for the transport of light and heavy fuel oils and pumps for waste oil and tank residues with abrasive solids.

Shipbuilding

Use as loading/unloading and transfer pumps for the transport of neutral or corrosive feed stock and finished products with high or low viscosity.

DESIGN AND OPERATION

Selfpriming Screw Pump with two screws in double volute and hy-draulically balanced design. The drive torque is transmitted from the double helix drive screw to the likewise double helix idler screw via herringbone gears.

The screws rotate closely meshing but without contact in the spindle bore of the interchangeable pump casing insert. As a result of the special profile geometry sealed cavities are formed which transport the pumped liquid continuously with low shear and without turbulences from both suction chambers axially to the di-charge chamber.

For optimum strength and low shaft deflection both drive screw and idler screw are manufactured from single piece bar stock.



L4

Pumpen Beschreibung / Pump Description

PULSATION - GERÄUSCHPEGEL

Die konstruktive Auslegung und die Wirkungsweise der Pumpen gewährleistet einen niedrigen Geräuschpegel und nahezu pulsationslose Förderung.

LAGERUNG

Antriebsspindel und Laufspindel werden antriebsseitig und getriebeseitig außerhalb des Förderraumes in Pendelrollenlagern oder Kegelrollenlagern gelagert. Da die Lager nicht mit dem Fördermedium in Berührung kommen, sind die Pumpen auch zur Förderung von nicht schmierenden und aggressiven Medien geeignet. Für Hochtemperaturanwendungen steht eine Lagervariante mit Zwischenlaterne und gekühlten Lagern zur Verfügung.

Alle Lager sind ölgeschmiert.

WELLENABDICHTUNG

Die Abdichtung von Antriebsspindel und Laufspindel erfolgt antriebsseitig und getriebeseitig mittels nicht entlasteten oder entlasteten, einfach- oder doppeltwirkenden, wartungsfreien Gleitringdichtungen gemäß DIN 24290.

Dichtungshersteller, Werkstoffe und Ausführung werden den jeweiligen Betriebsverhältnissen angepasst.

DRUCKBEGRENZUNGSVENTIL

Leistritz Schraubenspindelpumpen der Baureihe L4 können mit angebautem Druckbegrenzungsventil geliefert werden. Bei Überschreiten der Einstellwerte hebt der Ventilkegel von der Sitzfläche ab und das Fördermedium strömt zurück in den Saugraum oder die Saugleitung der Pumpe. Der Öffnungsdruck wird durch Vorspannung der Ventilfeeder mittels einer Stellschraube eingestellt.

Wird pumpenseitig kein Druckbegrenzungsventil gefordert und installiert, muss in der Druckleitung immer ein separater Überlastschutz vorgesehen werden.

Das Druckbegrenzungsventil der Pumpe darf nicht zur Absicherung der Anlage oder zur Fördermengenregulierung eingesetzt werden.

WELLENKUPPLUNG - KUPPLUNGSSCHUTZ

Wellenkupplungen gemäß DIN 740 und Kupplungsschutze werden als Zubehör geliefert. Standardmäßig werden dreiteilige, drehelastische Klauenkupplungen mit Ausbaustück eingesetzt. Alternativ sind auch andere Kupplungsvarianten, wie Ganzstahlkupplungen, lieferbar. Kupplungen und Kupplungsschutze sind auf Wunsch in API oder ATEX Versionen verfügbar.

PULSATION - NOISE LEVEL

The design and the working principle of the pumps guarantee a low noise level and an almost pulsation-free operation.

BEARING

Drive screw and idler screw are carried in spherical roller bearings or tapered roller bearings located outside the pumping chamber on drive end and gear side. The bearings are not in contact with the pumped liquid and hence, the pumps are suitable to handle non-lubricating and corrosive products.

A bearing option with an intermediate lantern and bearing cooling is available for high temperature applications.

All bearings are oil lubricated.

SHAFT SEALS

Drive screw and idler screw are sealed by unbalanced or balanced, single or double acting, maintenance-free mechanical seals in acc. with DIN 24290 on drive side and gear side.

Seal manufacturer, materials and design are selected to match the actual operating conditions.

PRESSURE RELIEF VALVE

Leistritz Screw Pumps Series L4 can be delivered with a built-on pressure relief valve. In case the pre-set values are exceeded, the valve cone lifts from its seat and the pump liquid flows back either to the suction chamber of the pump or to the suction piping. The valve opening pressure can be adjusted by tensioning the valve spring by means of a set screw.

In case the pump is not fitted with a pressure relief valve, the discharge pipework must be generally equipped with an adequate overload protection.

The pressure relief valve of the pump must not be used to safeguard the downstream pipework and equipment or for flow control purposes.

SHAFT COUPLING - COUPLING GUARD

Shaft couplings in accordance with DIN 740 and coupling guards are supplied as accessories. As a standard, torsionally flexible three-piece couplings with an elastic spider are used. Different coupling types, e.g. all metal couplings can be delivered as an option. Upon request couplings and coupling guards in accordance with API and ATEX requirements are available.

Pumpen Beschreibung / Pump Description

EINBAU / ANTRIEB

Leistritz Schraubenspindelpumpen der Baureihe L4 werden horizontal auf einem gemeinsamen Grundrahmen aufgestellt und über elastische Kupplungen mit Ausbaustück oder Schaltkupplungen mit Elektromotoren, Hydraulikmotoren oder Verbrennungsmotoren verbunden. Auf Wunsch können die Aggregate auch mit Getriebemotoren, Regelgetrieben oder Flüssigkeitkupplungen geliefert werden.

INSTALLATION / DRIVE

Leistritz Screw Pumps of the L4 Series are mounted horizontally on common baseplates. They are connected via flexible spacer type couplings or clutches to electric motors, hydraulic motors or combustion engines.

Upon request, the pump units can be supplied with geared motors, mechanical variable speed gears or fluid couplings.

WERKSTOFFE L4NG/MG/HG

Pumpengehäuse	Kohlenstoffstahl (1.0038, 1.0570) oder Edelstahl (1.4571)
Gehäuseeinsatz	Grauguss (0.6025), Sphäroguss (0.7040), Stahlguss (1.0619), Edelstahlguss (1.4408, 1.4470)
Antriebs- und Laufspindeln	Gehärteter Einsatzstahl (1.7139, 1.8550), Gehärteter Edelstahl (1.4122, 1.4542)
Gehäusedeckel	Kohlenstoffstahl (1.0038, 1.0570) oder Edelstahl (1.4571)
Gehäusedichtung	NBR oder FPM
Wellenabdichtung	Auswahl in Abhängigkeit von den Einsatzbedingungen

CONSTRUCTION MATERIALS L4NG/MG/HG

Pump Casing:	Carbon Steel (1.0038, 1.0570) or Stainless Steel (1.4571)
Casing Insert	Grey Cast Iron (0.6025), Nodular Cast Iron (0.7040), Cast Carbon Steel (1.0619), Cast Stainless Steel (1.4408, 1.4470)
Drive and Idler Screws	Case Hardening Steel (1.7139, 1.8550), Hardened Stainless Steel (1.4122, 1.4542)
Casing Cover	Carbon Steel (1.0038, 1.0570) or Stainless Steel (1.4571)
Casing Seals	NBR or FPM
Shaft Seals	Selection depending on the individual operating conditions

Leistritz Schraubenspindelpumpen der Baureihe L4 können auf Wunsch auch in, auf den jeweiligen Einsatzfall abgestimmten, Sonderwerkstoffen angeboten werden.

Upon request, Leistritz Screw Pumps Series L4 can be offered in special construction materials matching the particular application.

EINSATZGRENZEN L4NG/MG/HG

	Fördermenge Max.	Differenz- druck Max.	Viskosität Max.	Temperatur Max.
L4NG	5.000 m ³ /h 755,300 bpd	16 bar 222 psi	150.000 cSt	350°C 662°F
L4MG	3.900 m ³ /h 589,100 bpd	40 bar 580 psi	150.000 cSt	350°C 662°F
L4HG	2.000 m ³ /h 302,100 bpd	150 bar 2,175 psi	150.000 cSt	350°C 662°F

PERFORMANCE DATA L4NG/MG/HG

	Flow Rate- Max.	Differential Pressure- Max.	Viscosity- Max.	Pumping Temperature Max.
L4NG	5,000 m ³ /h 755,300 bpd	16 bar 222 psi	150,000 cSt	350°C 662°F
L4MG	3,900 m ³ /h 589,100 bpd	40 bar 580 psi	150,000 cSt	350°C 662°F
L4HG	2,000 m ³ /h 302,100 bpd	150 bar 2,175 psi	150,000 cSt	350°C 662°F



L4

Schnittzeichnung/Sectional Drawing

Baureihe/ Pump Series	Bauart/ Design	Baugröße/ Pump Size	Steigung/ Pitch	Bauform/ Design Code	Abdichtung/ Seal	Ausführung/Design
L4	NG	116 - 450	/ ...	AHOKR	G	2-spindelige, doppelflutige, horizontale Pumpe für Fußaufstellung; Double volute horizontal foot mounted twin screw pump
	MG	106 - 410				
	HG	100 - 365				

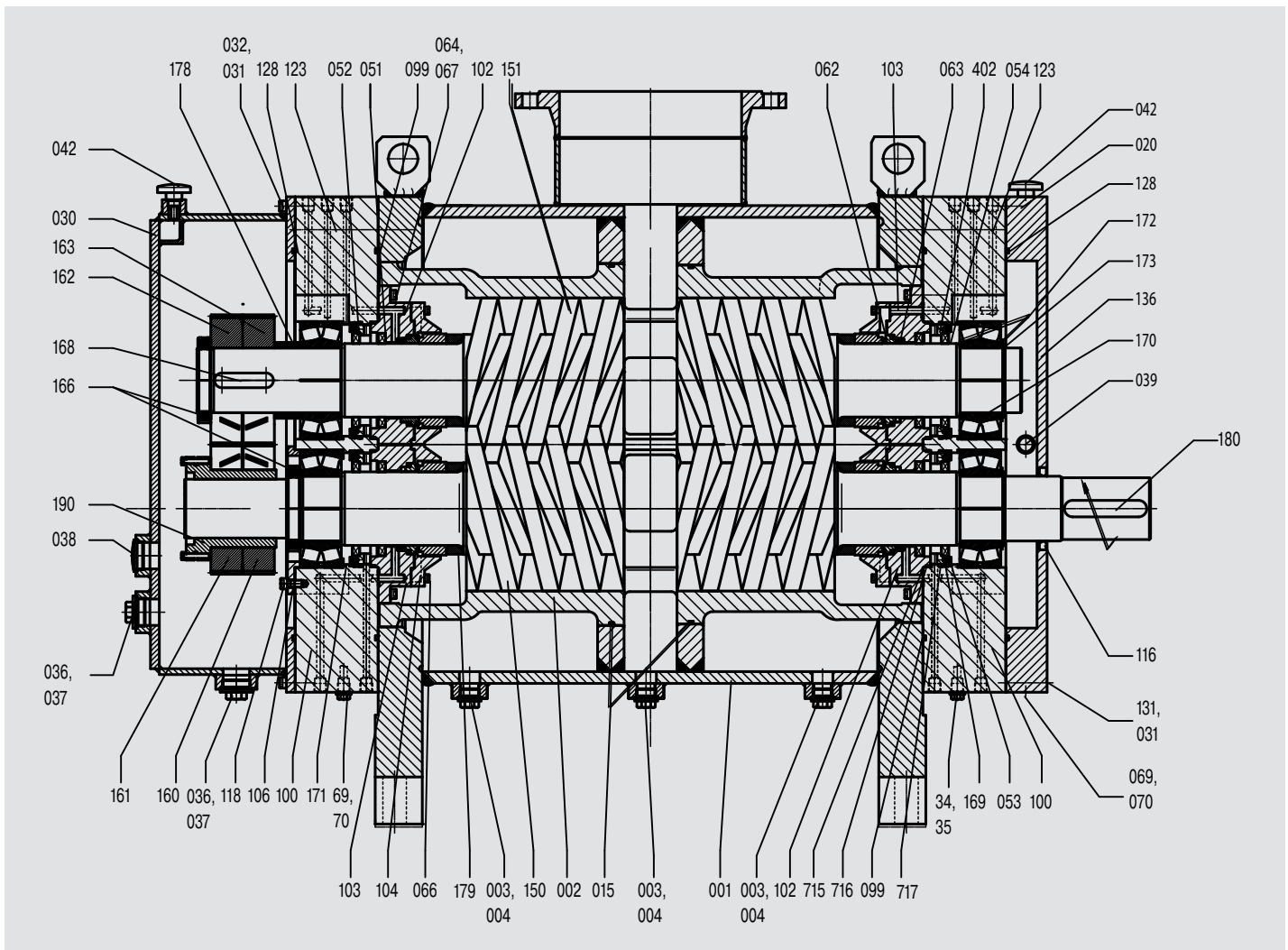

Stückliste/Parts List

Baureihe/ Pump Series	Bauart/ Design	Baugröße/ Pump Size	Steigung/ Pitch	Bauform/ Design Code	Abdichtung/ Seal	Ausführung/Design
L4	NG	116 - 450	/ ...	AHOKR	G	2-spindelige, doppelflutige, horizontale Pumpe für Fußaufstellung; Double volute horizontal foot mounted twin screw pump
	MG	106 - 410				
	HG	100 - 365				

Pos.	Bezeichnung	Description
1	Pumpengehäuse	pump casing
2	Gehäuseeinsatz	casing insert
3	Verschlussschraube	plug
4	Dichtring	sealing ring
15	O-Ring	o-ring
20	Zylinderstift	cylindrical pin
30	Getriebedeckel	gear cover
31	Zylinderstift	cylindrical pin
32	Befestigungsschraube	mounting screw
36	Verschlussschraube	plug
37	Dichtring	sealing ring
38	Ölschauglas	oil sight glas
39	Ölschauglas	oil sight glas
42	Luftfilter	air filter
51	Wellendichtring	shaft sealing ring
52	Wellendichtring	shaft sealing ring
53	Sicherungsring	circlip
54	Sicherungsring	circlip
61	Passfeder	key
62	Gleitringdichtung	mechanical seal
64	Zylinderstift	cylindrical pin
66	Befestigungsschraube	mounting screw
67	Befestigungsschraube	mounting screw
69	Dichtring	sealing ring
70	Verschlussschraube	plug
71	Schraube	screw
99	O-Ring	o-ring
100	Lagergehäuse	bearing housing
102	Dichtungsgehäuse	sealing casing

Pos.	Bezeichnung	Description
103	Dichtungsgehäuse	sealing casing
106	Klemmring	clamping ring
116	Wellendichtring	shaft sealing ring
118	Befestigungsschraube	mounting screw
123	Befestigungsschraube	mounting screw
128	O-Ring	o-ring
131	Befestigungsschraube	mounting screw
136	Lagerdeckel, antriebsseitig	end cover drive side
150	Antriebsspindel	driving spindle
151	Laufspindel	idler spindle
160	Getrieberad, Laufspindel, rechts	gear for idler spindle, right
161	Getrieberad, Laufspindel, links	gear for idler spindle, left
162	Getrieberad, Laufspindel, rechts	gear for idler spindle, right
163	Getrieberad, Laufspindel, links	gear for idler spindle, left
166	Kronenmutter	castle nut
168	Passfeder	key
169	Zylinderstift	cylindrical pin
170	Rollenlager	roller bearing
171	Stützring	supporting disk
172	Stützring	supporting disk
173	Sicherungsring	circlip
178	Abstandsring	spacer ring
179	Abstandsring	spacer ring
180	Passfeder	key
190	Klemmvorrichtung	clamping device
402	Dichtungsgehäuse	sealing casing
438	Ölschauglas	oil sight glas
715	O-Ring	o-ring
716	O-Ring	o-ring
717	O-Ring	o-ring



L4

Maßzeichnung/Dimensional Drawing

Baureihe/ Pump Series	Bauart/ Design	Baugröße/ Pump Size	Steigung/ Pitch	Bauform/ Design Code	Abdichtung/ Seal	Ausführung/ Design	Bemerkungen/ Remarks
L4	NG	116 - 450	/ ...	AHOKR	G	2-spindelige, doppelflutige, horizontale Pumpe für Fußaufstellung; Double volute horizontal foot mounted twin screw pump	Maße/ Dimensions: mm
	MG	106 - 410					
	HG	100 - 365					

MASSZEICHNUNG/DIMENSIONAL DRAWING L4

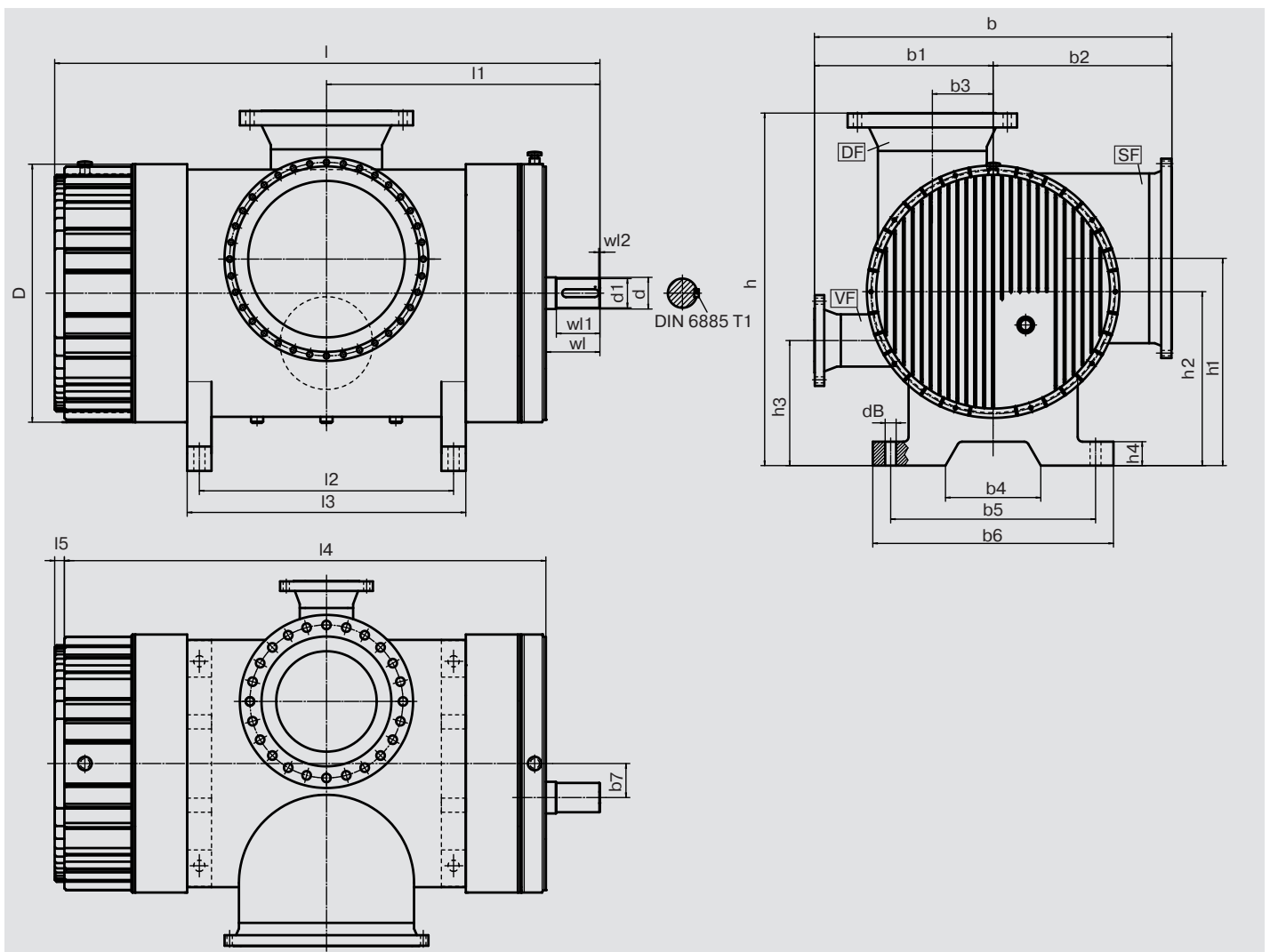

Maßblatt/Pump Dimensions

Baureihe/ Pump Series	Bauart/ Design	Baugröße/ Pump Size	Steigung/ Pitch	Bauform/ Design Code	Abdichtung/ Seal	Ausführung/ Design	Bemerkungen/ Remarks
L4	NG	116 - 450	/ ...	AHOKR	G	2-spindelige, doppelflutige, horizontale Pumpe für Fußaufstellung; Double volute horizontal foot mounted twin screw pump	Maße/ Dimensions: mm

MASSBLATT/PUMP DIMENSIONS* L4 NG

Bau- größe/ Pump Size	SF		DF		VF		b	b1	b2	b3	b4	b5	b6	b7
	ASME	DIN	ASME	DIN	ASME	DIN								
116	8" lbs 150	DN200 PN16	6" lbs 150	DN150 PN25	3" lbs 150	DN 80 PN25	590	280	310	75	140	280	320	42.5
135	10" lbs 150	DN250 PN16	6" lbs 150	DN150 PN25	4" lbs 150	DN100 PN25	700	360	340	110	160	350	400	50
150	12" lbs 150	DN300 PN16	8" lbs 300	DN200 PN25	4" lbs 150	DN100 PN25	760	360	400	110	180	390	450	55
176	16" lbs 150	DN400 PN16	10" lbs 300	DN250 PN25	6" lbs 150	DN150 PN25	920	440	480	135	220	490	550	64
220	18" lbs 150	DN450 PN16	12" lbs 300	DN300 PN25	6" lbs 150	DN150 PN25	1060	510	550	155	260	570	660	79
260	24" lbs 150	DN500 PN16	12" lbs 300	DN300 PN25	6" lbs 150	DN150 PN25	1160	570	590	185	280	620	710	94
310	26" lbs 150	DN650 PN16	16" lbs 300	DN400 PN25	8" lbs 150	DN200 PN25	1300	630	670	190	320	710	810	109
345	28" lbs 150	DN700 PN16	18" lbs 300	DN450 PN25	8" lbs 150	DN200 PN25	1380	680	700	225	360	790	910	125
405	34" lbs 150	DN850 PN16	20" lbs 300	DN500 PN25	-	-	1500	750	750	250	400	840	1010	140
450	38" lbs 150	DN950 PN16	24" lbs 300	DN600 PN25	-	-	1620	800	820	250	440	930	1110	155

MASSBLATT/PUMP DIMENSIONS* L4 NG

Bau- größe/ Pump Size	h	h1	h2	h3	h4	l	l1	l2	l3	l4	l5	D	DIN 6885 T1	d	d1	wl	wl1	wl2	dB
116	525	295	245	180	35	848	420	398	448	757	30	345	A 10 x 8 x 60	35	33	91	75	6	22
135	660	360	300	215	45	909.5	452.5	428	478	815	30	410	A 10 x 8 x 55	35	33	94.5	78.5	10	22
150	765	470	405	310	50	1030	503	490	540	945	35	474	A 14 x 9 x 70	50	45	85	80	5	22
176	895	525	455	340	55	1133	568.5	536	591	1020	40	550	A 16 x 10 x 85	60	55	113	105	10	27
220	1015	600	505	370	65	1368.5	676	605	670	1216	40	666	A 20 x 12 x 130	80	75	152.5	140	5	33
260	1100	620	530	385	70	1528.5	748	717	787	1381	60	700	A 22 x 14 x 110	90	85	147.5	140	15	33
310	1260	690	630	465	80	1700	850	856	936	1522	65	842	A 28 x 16 x 140	110	105	178	152	6.5	38
345	1360	770	680	495	90	2046.5	1069	971	1061	1826	-	910	A 28 x 16 x 160	110	100	220.5	180	10	46
405	1480	800	730	525	100	2239	1148	1054	1154	2017	-	1060	A 32 x 18 x 150	130	120	222	179	5	46
450	1580	850	780	555	110	-	-	-	-	-	-	1130	A 36 x 20 x 220	140	130	299	264	35	46

* Änderungen ohne vorherige Ankündigung vorbehalten!
Subject to modifications without prior information!

DIN-Flansche/DIN Flanges: nach DIN EN 1092-1 Typ 11/ In acc. with DIN EN 1092-1, Type 11
ASME-Flansche/ASME Flanges: bis 24" nach ASME B16.5 RF/Up to 24" - ASME B16.5, RF
ab 26" nach ASME B16.47- Serie B RF/
26" and larger - ASME B16.47, Series B, RF



L4

Maßblatt/Pump Dimensions

Baureihe/ Pump Series	Bauart/ Design	Baugröße/ Pump Size	Steigung/ Pitch	Bauform/ Design Code	Abdichtung/ Seal	Ausführung/ Design	Bemerkungen/ Remarks
L4	MG	106 - 410	/ ...	AHOKR	G	2-spindelige, doppelflutige, horizontale Pumpe für Fußaufstellung; Double volute horizontal foot mounted twin screw pump	Maße/ Dimensions: mm

MASSZEICHNUNG/DIMENSIONAL DRAWING L4

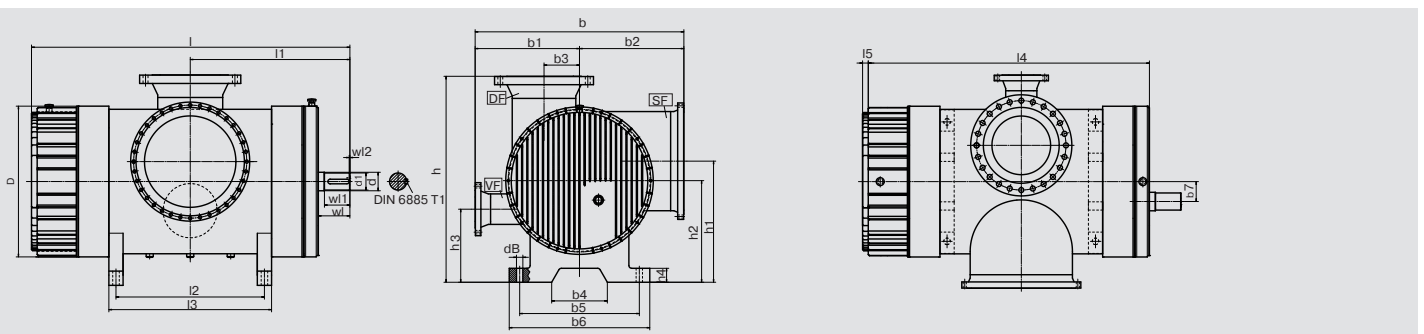

MASSBLATT/PUMP DIMENSIONS* L4MG

Baugröße/ Pump Size	SF		DF		VF		b	b1	b2	b3	b4	b5	b6	b7
	ASME	DIN	ASME	DIN	ASME	DIN								
106	10" 150 lbs	DN250 PN16	4" 300 lbs	DN100 PN40	3" 300 lbs	DN 80 PN40	590	280	310	95	140	280	320	42.5
126	10" 150 lbs	DN250 PN16	6" 300 lbs	DN150 PN40	4" 300 lbs	DN100 PN40	700	360	340	110	160	350	400	50
140	12" 150 lbs	DN300 PN16	6" 300 lbs	DN150 PN40	4" 300 lbs	DN100 PN40	760	360	400	135	180	390	450	55
164	16" 150 lbs	DN400 PN16	8" 300 lbs	DN200 PN40	4" 300 lbs	DN100 PN40	920	440	480	160	220	490	550	64
200	16" 150 lbs	DN400 PN16	10" 300 lbs	DN250 PN40	6" 300 lbs	DN150 PN40	1060	510	550	180	260	570	660	79
240	18" 150 lbs	DN450 PN16	12" 300 lbs	DN300 PN40	6" 300 lbs	DN150 PN40	1160	570	590	185	280	620	710	94
280	24" 150 lbs	DN600 PN16	14" 300 lbs	DN350 PN40	8" 300 lbs	DN200 PN40	1300	630	670	215	320	710	810	109
330	26" 150 lbs	DN650 PN16	16" 300 lbs	DN400 PN40	8" 300 lbs	DN200 PN40	1380	680	700	230	360	790	910	125
365	28" 150 lbs	DN700 PN16	18" 300 lbs	DN450 PN40	8" 300 lbs	DN200 PN40	1500	750	750	255	400	840	1010	140
410	32" 150 lbs	DN800 PN16	20" 300 lbs	DN500 PN40	10" 300 lbs	DN250 PN40	1620	800	820	270	440	930	1110	155

Baugröße/ Pump Size	h	h1	h2	h3	h4	l	l1	l2	l3	l4	l5	D	DIN 6885 T1	d	d1	wl	wl1	wl2	dB
106	525	265	245	180	35	848	420	398	448	757	30	345	A 10 x 8 x 60	35	33	91	75	6	22
126	660	350	300	215	45	909.5	452.5	428	478	815	30	410	A 10 x 8 x 55	35	33	94.5	78.5	10	22
140	765	465	405	310	50	1030	503	490	540	945	35	474	A 14 x 9 x 70	50	45	85	80	5	22
164	895	525	455	340	55	1133	568.5	536	591	1020	40	550	A 16 x 10 x 85	60	55	113	105	10	27
200	1015	625	505	370	65	1368.5	676	605	670	1216	40	666	A 20 x 12 x 130	80	75	152.5	140	5	33
240	1100	655	530	385	70	1528.5	748	717	787	1381	60	700	A 22 x 14 x 110	90	85	147.5	140	15	33
280	1260	730	630	465	80	1700	850	856	936	1522	65	842	A 28 x 16 x 140	110	105	178	152	6.5	38
330	1360	795	680	495	90	2046.5	1069	971	1061	1826	-	910	A 28 x 16 x 160	110	100	220.5	180	10	46
365	1480	870	730	525	100	2239	1148	1054	1154	2017	-	1060	A 32 x 18 x 150	130	120	222	179	5	46
410	1580	915	780	555	110	-	-	-	-	-	-	1130	A 36 x 20 x 220	140	130	299	264	35	46

* Änderungen ohne vorherige Ankündigung vorbehalten!
Subject to modifications without prior information!

DIN-Flansche/DIN Flanges: nach DIN EN 1092-1 Typ 11/ In acc. with DIN EN 1092-1, Type 11
ASME-Flansche/ASME Flanges: bis 24" nach ASME B16.5 RF/Up to 24" - ASME B16.5, RF
ab 26" nach ASME B16.47 - Serie B RF/
26" and larger - ASME B16.47, Series B, RF

Maßblatt/Pump Dimensions

Baureihe/ Pump Series	Bauart/ Design	Baugröße/ Pump Size	Steigung/ Pitch	Bauform/ Design Code	Abdichtung/ Seal	Ausführung/ Design	Bemerkungen/ Remarks
L4	HG	100 - 365	/ ...	AHOKR	G	2-spindelige, doppelflutige, horizontale Pumpe für Fußaufstellung; Double volute horizontal foot mounted twin screw pump	Maße/ Dimensions: mm

MASSBLATT/PUMP DIMENSIONS* L4HG

Bau- größe/ Pump Size	SF		DF		VF		b	b1	b2	b3	b4	b5	b6	b7
	ASME	DIN	ASME	DIN	ASME	DIN								
100	10" 150 lbs	DN250 PN16	4" 900 lbs	DN100 PN160	1,5" 900 lbs	DN 40 PN160	590	280	310	115	140	310	350	42.5
116	12" 150 lbs	DN300 PN16	6" 900 lbs	DN150 PN160	2" 900 lbs	DN 50 PN160	700	360	340	115	160	350	400	50
128	12" 150 lbs	DN300 PN16	6" 900 lbs	DN150 PN160	2" 900 lbs	DN 50 PN160	760	360	400	135	180	390	450	55
150	16" 150 lbs	DN400 PN16	8" 900 lbs	DN200 PN160	3" 900 lbs	DN 80 PN160	920	440	480	160	220	490	550	64
186	18" 150 lbs	DN450 PN16	10" 900 lbs	DN250 PN160	4" 900 lbs	DN100 PN160	1060	510	550	180	260	570	660	79
220	20" 150 lbs	DN500 PN16	12" 900 lbs	DN300 PN160	4" 900 lbs	DN100 PN160	1160	570	590	190	280	620	710	94
256	26" 150 lbs	DN650 PN16	14" 900 lbs	DN350 PN160	4" 900 lbs	DN100 PN160	1300	630	670	220	320	710	810	109
295	28" 150 lbs	DN700 PN16	16" 900 lbs	DN400 PN160	6" 900 lbs	DN150 PN160	1380	680	700	250	360	790	910	125
330	34" 150 lbs	DN850 PN16	18" 900 lbs	DN450 PN160	6" 900 lbs	DN150 PN160	1500	750	750	275	400	840	1010	140
365	38" 150 lbs	DN950 PN16	20" 900 lbs	DN500 PN160	6" 900 lbs	DN150 PN160	1620	800	820	300	440	930	1110	155

Bau- größe/ Pump Size	h		h1		h2		h3		h4		l		l1		l2		l3		l4		l5		D		DIN 6885 T 1		d		d1		wl		wl1		wl2		dB	
	h	h1	h2	h3	h4	l	l1	l2	l3	l4	l5	D	DIN 6885 T 1	d	d1	wl	wl1	wl2	dB																			
100	580	295	255	180	35	848	420	398	448	757	30	345	A 10 x 8 x 60	35	33	91	75	6	22																			
116	660	335	300	215	45	909.5	452.5	428	478	815	30	370	A 10 x 8 x 55	35	33	94.5	78,5	10	22																			
128	885	465	405	310	50	1030	503	490	540	945	35	474	A 14 x 9 x 70	50	45	85	80	5	22																			
150	935	525	455	340	55	1133	568.5	536	591	1020	40	550	A 16 x 10 x 85	60	55	113	105	10	27																			
186	1065	595	505	370	65	1368.5	676	605	670	1216	40	665	A 20 x 12 x 130	80	75	152.5	140	5	33																			
220	1150	620	530	385	70	1528.5	748	717	787	1381	60	700	A 22 x 14 x 110	90	85	147.5	140	15	33																			
256	1290	680	630	465	80	1700	850	856	936	1522	65	842	A 28 x 16 x 140	110	105	178	152	6.5	38																			
295	1420	770	680	495	90	2046.5	1069	971	1061	1826	-	909	A 28 x 16 x 160	110	100	220.5	180	10	46																			
330	1530	790	730	525	100	2239	1148	1054	1154	2017	-	1060	A 32 x 18 x 150	130	120	222	179	5	46																			
365	1640	840	780	555	110	-	-	-	-	-	-	1130	A 36 x 20 x 220	140	130	299	264	35	46																			

* Änderungen ohne vorherige Ankündigung vorbehalten!
Subject to modifications without prior information!

DIN-Flansche/DIN Flanges: nach DIN EN 1092-1 Typ 11/ In acc. with DIN EN 1092-1, Type 11
ASME-Flansche/ASME Flanges: bis 24" nach ASME B16.5 RF/Up to 24" - ASME B16.5, RF
ab 26" nach ASME B16.47- Serie B RF/
26" and larger - ASME B16.47, Series B, RF



L4

Pumpen-Typenschlüssel und Bauform/ Pump Type Code and Design

BAUREIHE/PUMP SERIES										BAUGRÖSSE/PUMP SIZE				BAUFORM/DESIGN CODE																
Spindelzahl/ No. of Screws					Druckbereich/ Pressure Ranges					Bauart/ Design					Außen Ø Antriebs- triebsspindel/ Drive Screw OD		Steigung/ Pitch		Lager/ Bearing			Befestigung/ Mounting								
LEISTRITZ	2 Spindeln 2-Spindle	3 Spindeln 3-Spindle	4 Spindel-sätze 4-Spindle Set	5 Spindeln 5-Spindle	Niederdruck Low Pressure	Mitteldruck Medium Pressure	Hochdruck High Pressure	Sehr hoher Druck Very High Pressure	Gehäuse Pump Casing	Flansch Flange	Tauchpumpe Semi Submersible	Ohne Einschub Without Insert	Kurze Ausführung Short Design	-	150	/	033	-	Wälzlager Roller Bearing											
L	4				N				G									Innen Internal			Außen External		Verstärkt Reinforced		Gleitlager Sleeve Bearing		Fuß Foot		Flansch Flange	

L	2	3	4	5	N	M	H	V	G	F	T	O	K	-	/	-	I	A	V	G	H	F														
L	4				N				G					-	116	/	26 37 47 58 69	-																				
															135		30 42 55 67 80																					
															150		33 47 61 76 90																					
															176		39 55 72 88 105																					
															220		48 68 89 109 130																					
															260		57 81 105 128 150																					
															310		68 95 123 150 178																					
															345		76 107 138 169 200																					
															405		89 117 144 172 200																					
															450		100 125 150 175 200																					

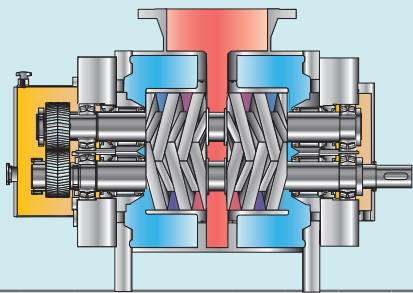

L	2	3	4	5	N	M	H	V	G	F	T	O	K	-	/	-	I	A	V	G	H	F												
L	4				M				G					-	106	/	25 35 45 50 59	-																		
															126		28 38 48 58 68																			
															140		31 43 54 66 77																			
															164		36 50 63 77 90																			
															200		45 55 70 85 100 110																			
															240		55 75 90 110 130																			
															280		62 85 110 130 153																			
															330		72 100 125 150 176																			
															365		80 110 160 170 197																			
															410		90 120 145 170 200																			

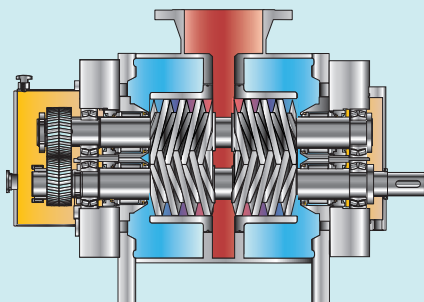

L	2	3	4	5	N	M	H	V	G	F	T	O	K	-	/	-	I	A	V	G	H	F											
L	4				H				G					-	100	/	22 30 40 50 58	-																	
															116		26 36 47 57 68																		
															128		28 40 52 65 77																		
															150		33 47 61 75 90																		
															186		41 55 75 90 105																		
															220		48 65 85 100 120																		
															256		56 75 95 115 136																		
															295		65 90 120 150 176																		
															330		72 95 120 140 164 198																		
															365		80 110 140 170 200																		

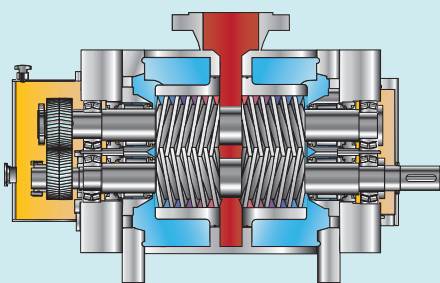

Pumpen-Typenschlüssel und Bauform/ Pump Type Code and Design

ng/ ng	Beheizung/ Heating					Befest. Flansch/ Mount.-Flange		Saug-Druckseite/ Inlet - Outlet								Sicherheits- ventil/ Relief Valve			ABDICHTUNG/SEAL								
	Ohne Heizung Without Heating	Heizschale oder -fuss Heat. Chamber or Heating Foot	Mantelheizung Heating Jacket	Deckel-/Fussheizung Foot/End Cover Heating	Sockelheizung Heating Pedestal	Klein Small	Groß Large	Ohne Sauganschluß Without Suct. Housing	Ansaugsieb Inlet Strainer	Tauchrohr Immersion Tube	Sauggehäuse Suction Casing	Umlaufventil Circulation Valve	Inline Inline	Versetzt Staggered	Rechtwinklig Side in Top out	Nebeneinander Side by Side	Drucktopf Pressure Casing	Ohne Ventil Without Valve	Aufgesetztes Ventil - geflanscht Top Mounted Valve - flanged	Integriert Integrated Valve	Wellenabdichtung/ Shaft Sealing						
Socket Pedestal	O																				G						

S	O	H	M	D	S	K	G	O	A	T	S	U	I	V	R	N	D	O	A	I	-	G	W	Q	S	O	M	D
•	•		•	•									•		•			•	•		-	•		•				
•	•		•	•									•		•			•	•		-	•		•				
•	•		•	•									•		•			•	•		-	•		•				
•	•		•	•									•		•			•	•		-	•		•				
•	•		•	•									•		•			•	•		-	•		•				
•	•		•	•									•		•			•	•		-	•		•				
•	•		•	•									•		•			•	•		-	•		•				
•	•		•	•									•		•			•	•		-	•		•				
•	•		•	•									•		•			•	•		-	•		•				
•	•		•	•									•		•			•	•		-	•		•				

S	O	H	M	D	S	K	G	O	A	T	S	U	I	V	R	N	D	O	A	I	-	G	W	Q	S	O	M	D
•	•		•	•									•		•			•	•		-	•		•				
•	•		•	•									•		•			•	•		-	•		•				
•	•		•	•									•		•			•	•		-	•		•				
•	•		•	•									•		•			•	•		-	•		•				
•	•		•	•									•		•			•	•		-	•		•				
•	•		•	•									•		•			•	•		-	•		•				
•	•		•	•									•		•			•	•		-	•		•				
•	•		•	•									•		•			•	•		-	•		•				
•	•		•	•									•		•			•	•		-	•		•				
•	•		•	•									•		•			•	•		-	•		•				

S	O	H	M	D	S	K	G	O	A	T	S	U	I	V	R	N	D	O	A	I	-	G	W	Q	S	O	M	D
	•		•	•									•		•			•	•		-	•		•				
	•		•	•									•		•			•	•		-	•		•				
	•		•	•									•		•			•	•		-	•		•				
	•		•	•									•		•			•	•		-	•		•				
	•		•	•									•		•			•	•		-	•		•				
	•		•	•									•		•			•	•		-	•		•				
	•		•	•									•		•			•	•		-	•		•				
	•		•	•									•		•			•	•		-	•		•				
	•		•	•									•		•			•	•		-	•		•				
	•		•	•									•		•			•	•		-	•		•				



L4

Kennfelder/Performance Characteristics

KENNFELD/PERFORMANCE CHARACTERISTICS L4NG

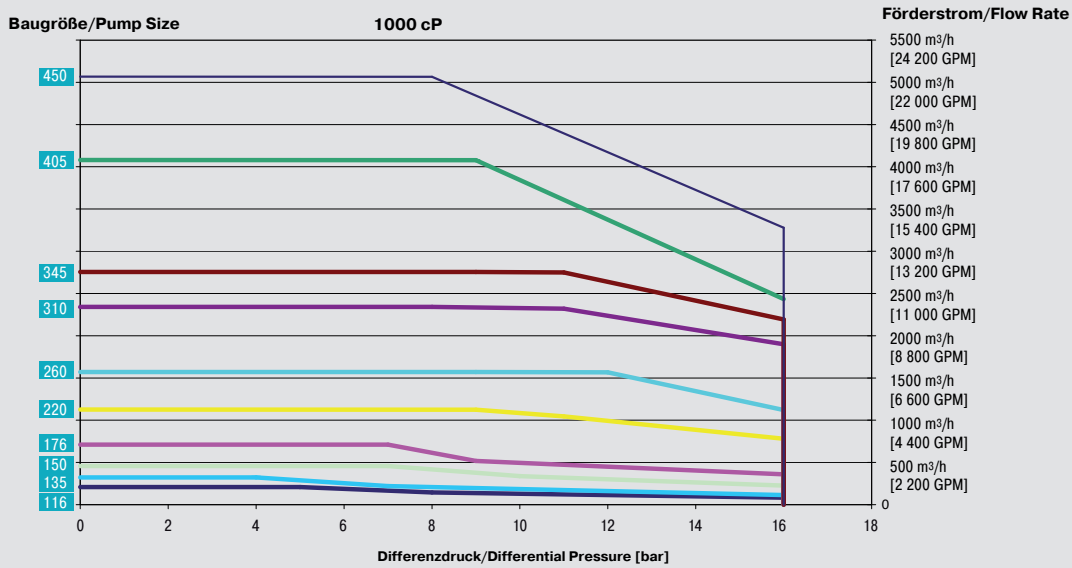

KENNFELD/PERFORMANCE CHARACTERISTICS L4MG

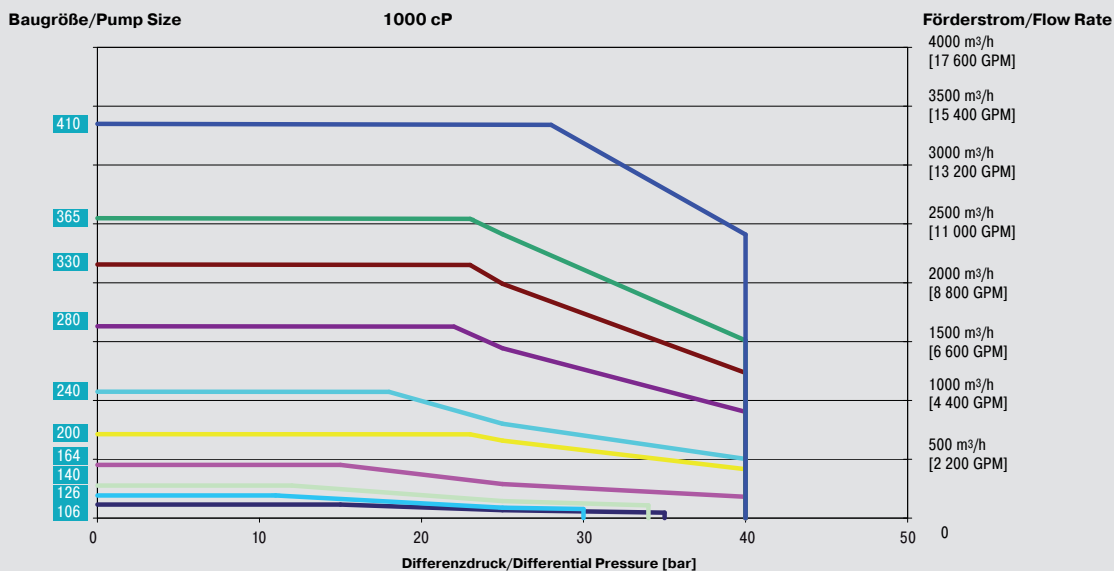

Kennfelder/Performance Characteristics

KENNFELD/PERFORMANCE CHARACTERISTICS L4HG

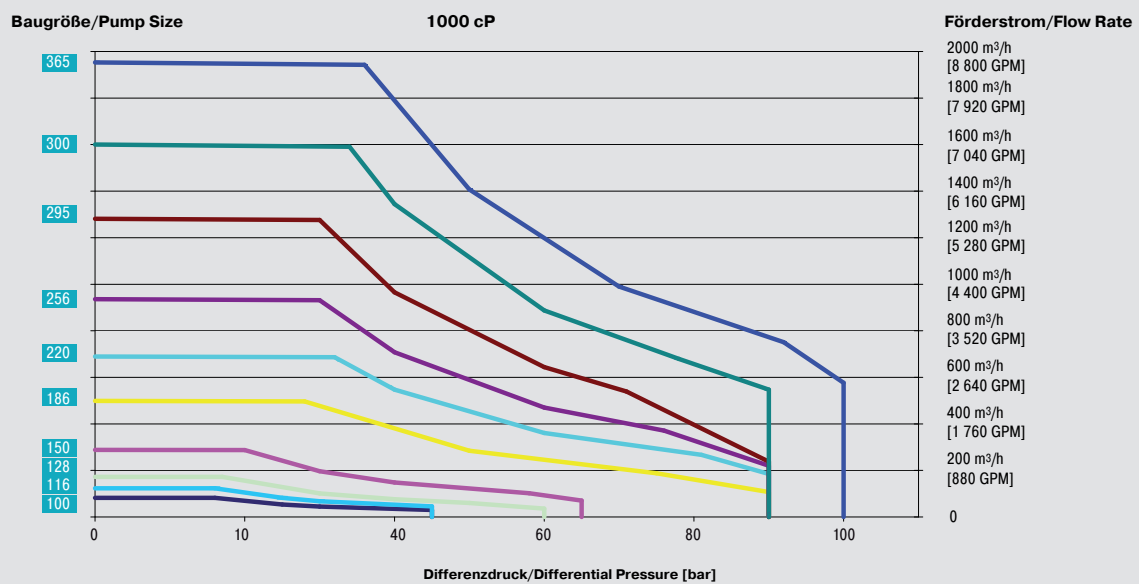



L4

Baukastensystem/Modular System

BAUKASTENSYSTEM

Die Bauteile der Leistritz L4 Nieder-, Mittel- und Hochdruckpumpen werden nach einem Baukastensystem hergestellt. Pumpengehäuse, Lagerdeckel, Lager, Gleitringdichtungen einschließlich der Einbauteile sowie die Getrieberäder sind innerhalb der verschiedenen Baureihen austauschbar. In Anlagen mit Pumpen unterschiedlicher Baugrößen und Baureihen ermöglicht das Baukastensystem eine einfache und kostengünstige Ersatzteilhaltung. Das Baukastensystem deckt sowohl Industrielle- als auch Multiphasen-Anwendungen der Leistritz L4 Baureihe ab.

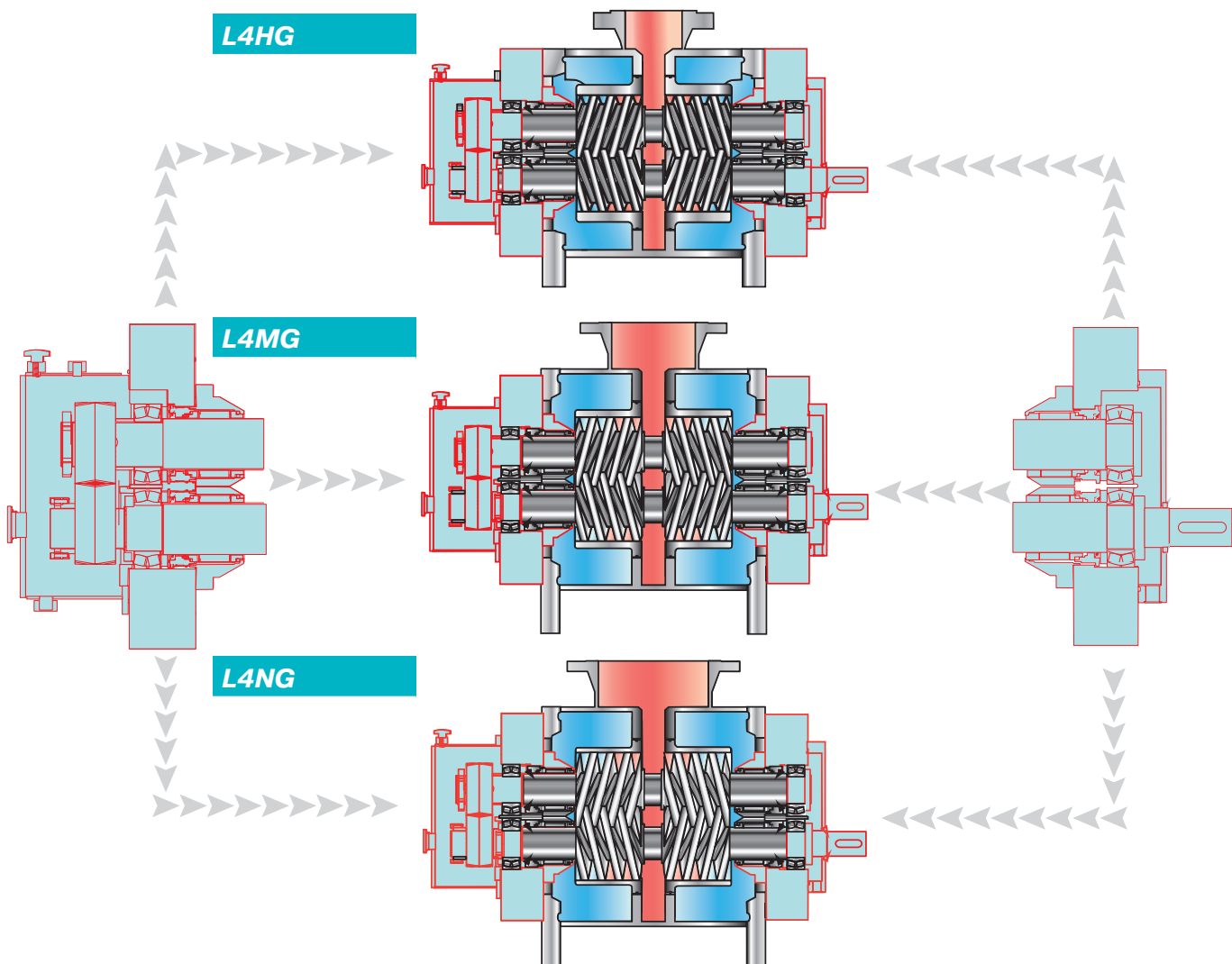

Baukastensystem/Modular System

MODULAR SYSTEM

The components of the low, medium and high pressure pumps are produced to a modular system.

Pump casings, bearing covers, bearings, mechanical seals, mechanical seal installation parts and the timing gears are interchangeable among pumps of different sizes.



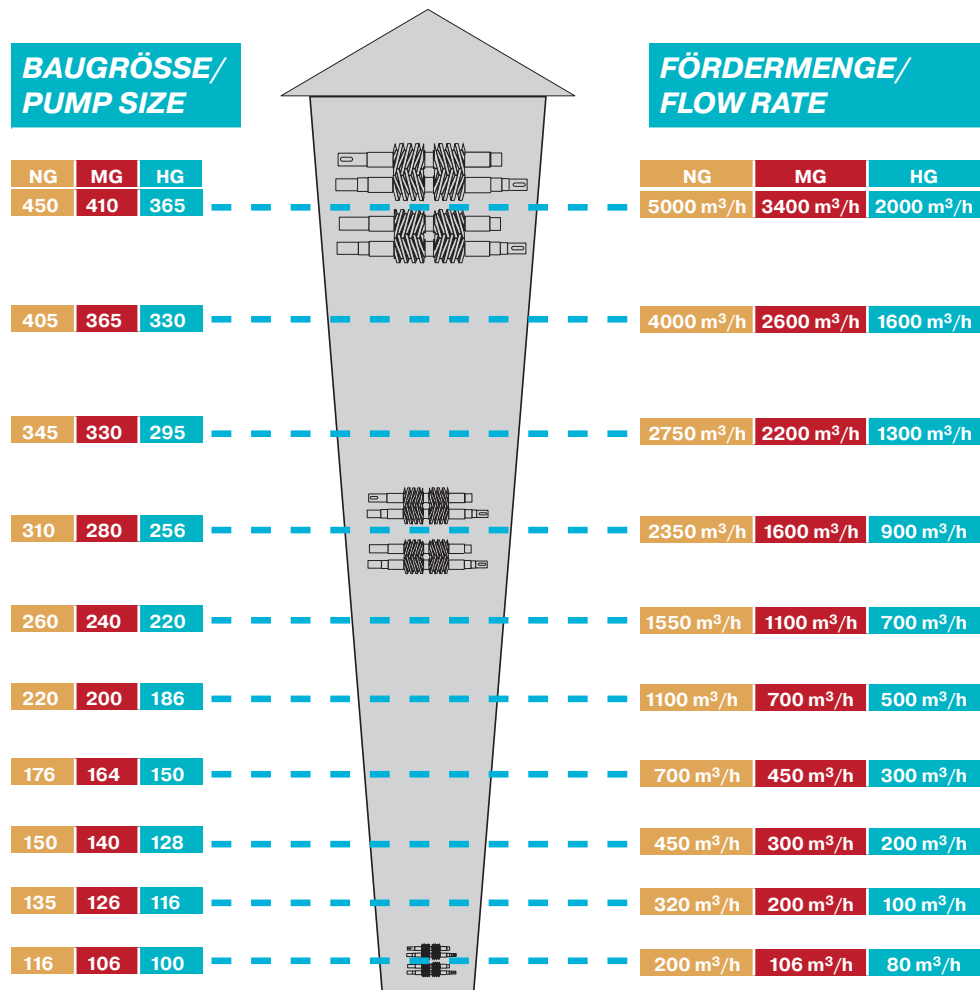

For installations with different pump sizes and designs the modular system for the Leistritz L4 Series Twin Screw Pumps permits simple and economical keeping of a spare parts inventory.

The modular system covers both Industrial and Multiphase Pumps of the Leistritz L4 Series.









L4 Anwendungen/Applications

	ANWENDUNG/ APPLICATION	Leistrizt L4 Schraubenspindelpumpen als Pipeline Druckerhöhungspumpen in Kasachstan/ Leistrizt L4 Series Twin Screw Pumps as Pipeline Booster Pumps in Kazakhstan
	FÖRDERMEDIUM/ PUMPED LIQUID	Crude Oil/Rohöl
	FÖRDERMENGE/ FLOW RATE	Q = 180 m ³ /h [793 GPM]
	DIFFERENZDRUCK/ DIFFERENTIAL PRESSURE	ΔP = 60 bar [870 PSI]
	ANWENDUNG/ APPLICATION	Leistrizt L4 Schraubenspindelpumpe als Pipeline Start-Up Pumpe in Afrika/ Leistrizt L4 Twin Screw Pump as Pipeline Start-Up Pump in Africa
	FÖRDERMEDIUM/ PUMPED LIQUID	Rohöl/Crude Oil
	FÖRDERMENGE/ FLOW RATE	Q = 60 m ³ /h [265 GPM]
	DIFFERENZDRUCK/ DIFFERENTIAL PRESSURE	ΔP = 81 bar [1175 PSI]
	ANWENDUNG/ APPLICATION	Leistrizt L4 Schraubenspindelpumpe als Ent- und Beladepumpe in einer Raffinerie in Surinam/ Leistrizt L4 Twin Screw Pump as Loading and Unloading Pump in a Refinery in Surinam
	FÖRDERMEDIUM/ PUMPED LIQUID	Rohöl/Crude Oil
	FÖRDERMENGE/ FLOW RATE	Q = 630 m ³ /h [2774 GPM]
	DIFFERENZDRUCK/ DIFFERENTIAL PRESSURE	ΔP = 13 bar [189 PSI]
	ANWENDUNG/ APPLICATION	Leistrizt L4 Schraubenspindelpumpen in einer Raffinerie in Spanien/ Leistrizt L4 Twin Screw Pumps in a Refinery in Spain
	FÖRDERMEDIUM/ PUMPED LIQUID	Vakuum Rückstand/Vacuum Residue
	FÖRDERMENGE/ FLOW RATE	Q = 120 m ³ /h [529]
	DIFFERENZDRUCK/ DIFFERENTIAL PRESSURE	ΔP = 37 bar [537 PSI]
	ANWENDUNG/ APPLICATION	Leistrizt L4 Schraubenspindelpumpe in einem Tanklager in Singapur/ Leistrizt L4 Twin Screw Pump in a Tank Storage in Singapore
	FÖRDERMEDIUM/ PUMPED LIQUID	Diverse Roh- und Fertigprodukte/ Various Black and White Products
	FÖRDERMENGE/ FLOW RATE	Q = 2000 m ³ /h [8806 GPM]
	DIFFERENZDRUCK/ DIFFERENTIAL PRESSURE	ΔP = 11 bar [160 PSI]

Anwendungen/Applications

	ANWENDUNG/ APPLICATION	Leistritz L4 Schraubenspindelpumpe in einer Raffinerie in Russland/ Leistritz L4 Twin Screw Pump in a Refinery in Russia
	FÖRDERMEDIUM/ PUMPED LIQUID	Rohöl/Mazut
	FÖRDERMENGE/ FLOW RATE	Q = 350 m ³ /h [1541 GPM]
	DIFFERENZDRUCK/ DIFFERENTIAL PRESSURE	ΔP = 10 bar [145 PSI]
	ANWENDUNG/ APPLICATION	Leistritz L4 Schraubenspindelpumpe in einer Chemeanlage in den Niederlanden/ Leistritz L4 Twin Screw Pump in a Chemical Plant in the Netherlands
	FÖRDERMEDIUM/ PUMPED LIQUID	Polymer
	FÖRDERMENGE/ FLOW RATE	Q = 876 m ³ /h [3857 GPM]
	DIFFERENZDRUCK/ DIFFERENTIAL PRESSURE	ΔP = 48 bar [696 PSI]
	ANWENDUNG/ APPLICATION	Leistritz L4 Schraubenspindelpumpe auf einer Offshore-Plattform in China/ Leistritz L4 Twin Screw Pump on a Offshore Platform in China
	FÖRDERMEDIUM/ PUMPED LIQUID	Öl/Wasser-Gemisch/Oil- Water Mixture
	FÖRDERMENGE/ FLOW RATE	Q = 406 m ³ /h [1788 GPM]
	DIFFERENZDRUCK/ DIFFERENTIAL PRESSURE	ΔP = 12 bar [175 PSI]
	ANWENDUNG/ APPLICATION	Leistritz L4 Schraubenspindelpumpe in einer Chemeanlage in den Nordamerika/ Leistritz L4 Twin Screw Pump in a Chemical Plant in North America
	FÖRDERMEDIUM/ PUMPED LIQUID	Polymerlösung/Polymer Solution
	FÖRDERMENGE/ FLOW RATE	Q = 1460 m ³ /h [6428 GPM]
	DIFFERENZDRUCK/ DIFFERENTIAL PRESSURE	ΔP = 21 bar [305 GPM]

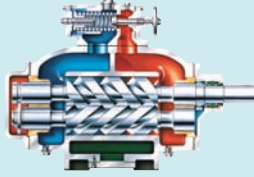
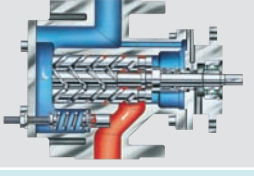
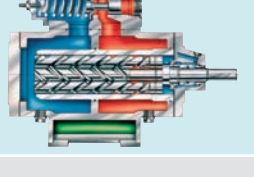
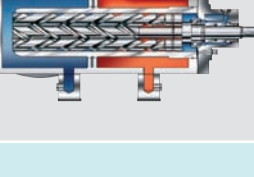
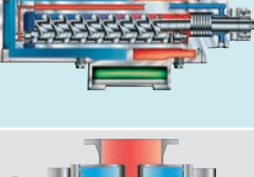
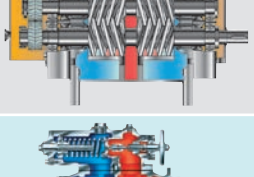
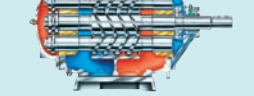

Leistritz Schraubenspindelpumpen Programm Leistritz Screw Pump Programm

Reihe/ Series	Anwendung für/Use for	Leistritz Schraubenspindel- pumpe/ Leistritz Screw Pump	Max. Einsatzgrenzen/ Max. Performance Data			
			Fördermenge/ Capacity	Differenzdruck/ Differential Pressure	Viskosität/ Viscosity	Betriebs- temperatur/ Pumping Temperature
L2	Niederdruckbereich und zur Förderung von bedingt aggressiven, leicht abrasiven, niedrig- bis hochviskosen Medien mit gut bis schlecht schmierenden Eigenschaften./ Low pressure duty, suitable for transport of light abrasive and corrosive, high or low viscous fluids with poor or good lubricity.		900 m ³ /h [3.960 gpm]	16 bar [232 psi]	100.000 cSt	280°C [536°F]
L3N	Niederdruckbereich und zur Förderung von schmierenden Medien, ohne abrasive Bestandteile./ Low pressure duty, suitable for transport of non-abrasive lubricating fluids.		700 m ³ /h [3.100 gpm]	16 bar [232 psi]	15.000 cSt	180°C [356°F]
L3M	Mitteldruckbereich und zur Förderung von schmierenden Medien, ohne abrasive Bestandteile./ Medium pressure duty, suitable for transport of non-abrasive lubricating fluids.		300 m ³ /h [1.320 gpm]	80 bar [1.160 psi]	10.000 cSt	280°C [536°F]
L3H	Hochdruckbereich und zur Förderung von schmierenden Medien, ohne abrasive Bestandteile./ High pressure duty, suitable for transport of non-abrasive lubricating fluids.		200 m ³ /h [880 gpm]	160 bar [2.320 psi]	10.000 cSt	280°C [536°F]
L3V/U	Ultra-Hochdruckbereich und zur Förderung von leicht abrasiven, niedrig- bis hochviskosen Medien mit gut bis schlecht schmierenden Eigenschaften./ Ultra high pressure duty suitable for transport of light abrasive and corrosive, high or low viscous fluids with poor or good lubricity.		180 m ³ /h [792 gpm]	280 bar [4.060 psi]	1.000 cSt	280°C [536°F]
L4	Nieder-/Mittel- und Hochdruckbereich und zur Förderung von aggressiven/nicht aggressiven, abrasiven/nicht abrasiven, niedrig- bis hochviskosen Medien mit schmierenden/nicht schmierenden Eigenschaften./ Low, medium and high pressure duty, suitable for transport of abrasive/non-abrasive, corrosive/non-corrosive, lubricating/non-lubricating, high or low viscous fluids.		5.000 m ³ /h [22.000 gpm]	150 bar [2.175 psi]	150.000 cSt	350°C [662°F]
L5	Niederdruckbereich und zur Förderung von bedingt aggressiven, leicht abrasiven, niedrig- bis hochviskosen Medien mit gut bis schlecht schmierenden Eigenschaften./ Low pressure duty, suitable for transport of light abrasive and corrosive, high or low viscous fluids with poor or good lubricity.		1.700 m ³ /h [7.500 gpm]	10 bar [145 psi]	100.000 cSt	280°C [536°F]

Weitere Leistungsdaten auf Anfrage/Exceeding operating conditions upon request.

LEISTRITZ PUMPEN GMBH
Markgrafenstraße 29-39
D-90459 Nürnberg
Tel.: +49 9 11/43 06 - 0
Fax: +49 9 11/43 06 - 490
E-Mail: pumpen@leistritz.com
www.leistritz.com

LEISTRITZ ITALIA SRL
Via dei Fontanili, 26
I-20141 Milan Italy
Phone: +39 / 0284477 451
+39 / 0284477 505
Fax: +39 / 0284477 444
E-Mail: pompeitalia@leistritz.com

Ihr Leistritz Partner/Your Leistritz Partner