

L4 SCREW PUMP SERIES

Screw Pumps & Systems



PUMP TECHNOLOGY

With experience and passion

Leistriz is the first address when it comes to the application of screw pumps. After all, the company, with its headquarters in Nuremberg, is one of the pioneers in the field of screw pumps: more than 90 years ago, it was Paul Leistriz, who used the twin screw pump for the first time to pump lube oil for steam turbine bearings. What started out small in 1924 is now a globally active company with more than 300 employees, which has the widest product range in the field of screw pumps. Leistriz Pump Technology has branches in all important markets, such as the USA, China, Singapore, Dubai, India and Italy. Leistriz customers benefit from valuable know-how in various industries and applications.

» Leistriz is the only producer in the world to offer the complete range of screw pumps. «

PUMP FACTS

The intelligent design of the Leistriz screw pumps offers enormous advantages over other pump technologies, like:

- low-pulsation pumping of the fluid
- extremely low vibration and noise
- high flow rates
- pumping a wide range of viscosities
- low-wear operation
- long service life

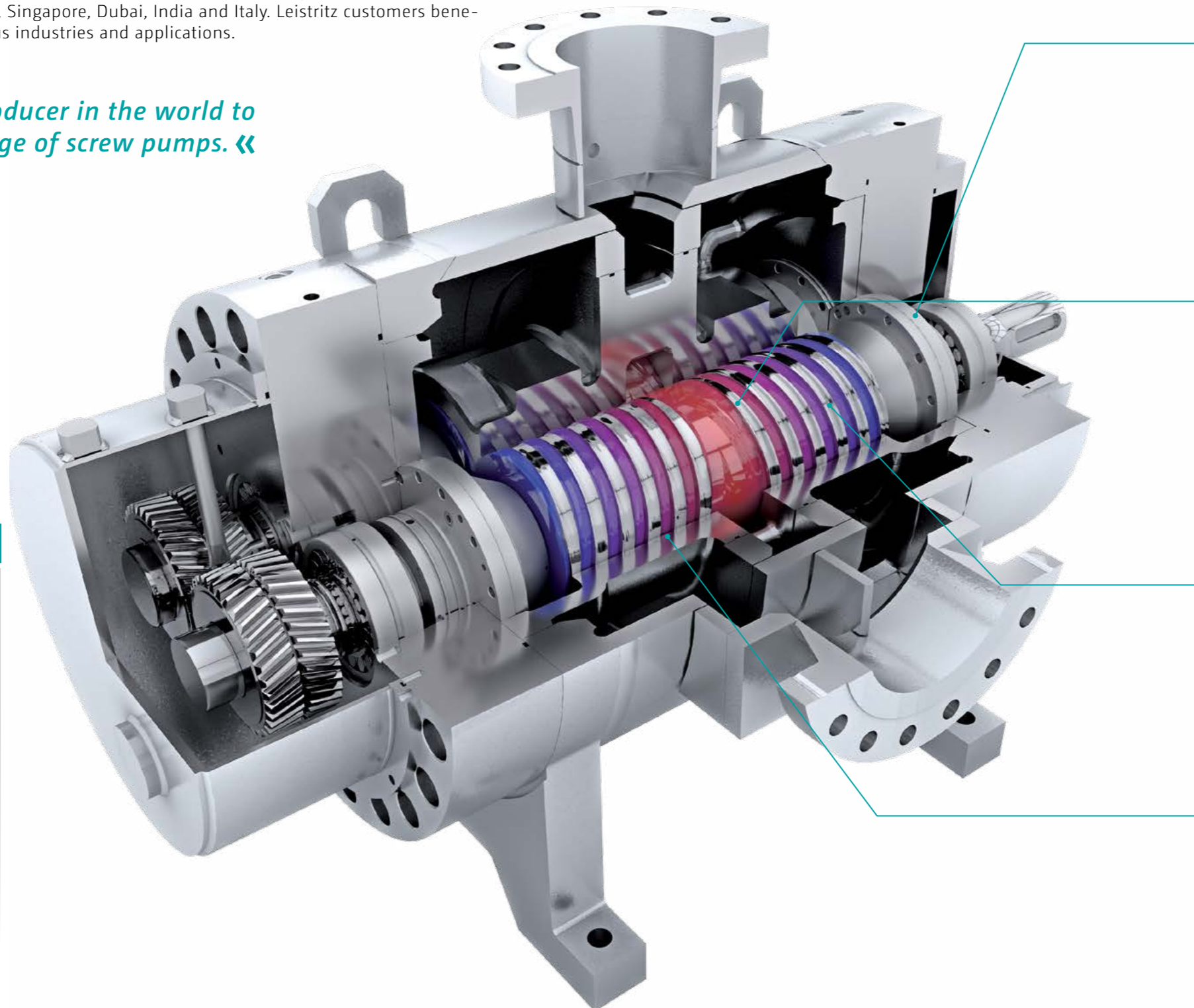

L4 SCREW PUMP

Superior technology & intelligent design

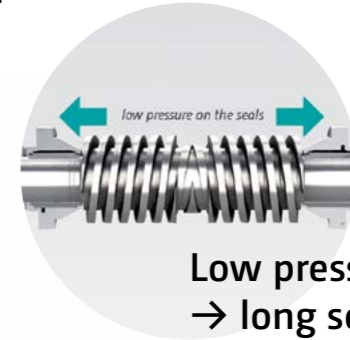

Low pressure on seals
→ long service life

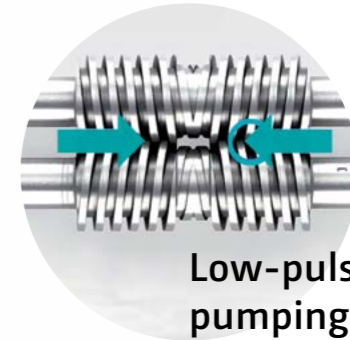

Low-pulsation
pumping of the fluid

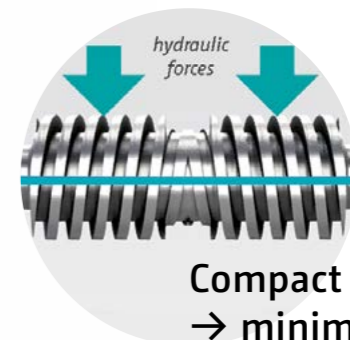

Compact design
→ minimum shaft deflection

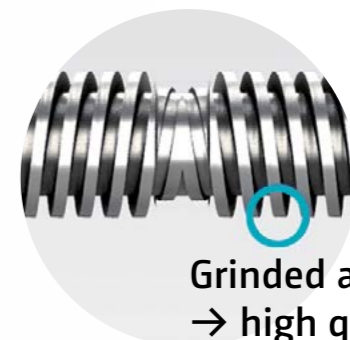

Grinded and hardened profile
→ high quality

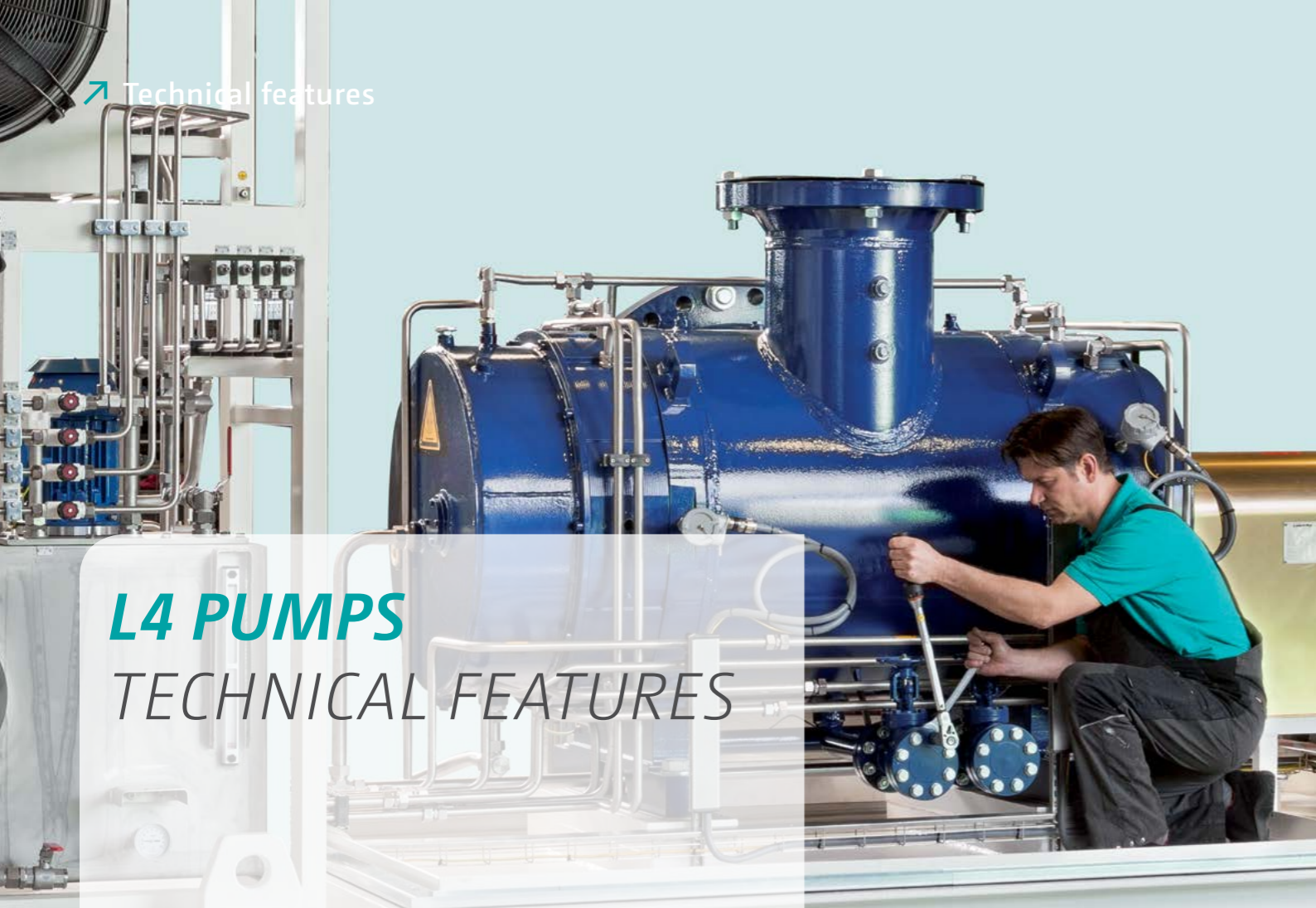

L4 PUMPS

TECHNICAL FEATURES

PUMP CASING

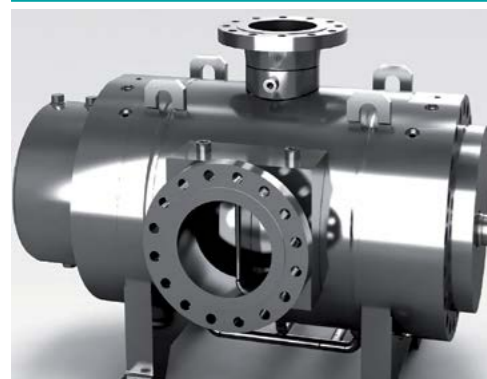

- Welded design with materials from carbon steel to stainless steel and up to duplex steel
- Casted design with materials from grey cast iron to nodular cast iron and up to cast steel
- Economic and slim design for reduced weight
- ANSI & DIN flanges possible
- Various flange sizes and positions
- Drain and vent connections

SPINDLES



- Single bar stock for maximum stiffness
- Case-hardened steel (1.7139), nitrided for max. hardness
- Tungsten carbide or stellite coating available for high wear resistance
- Side by side arrangement for excellent lubrication capabilities of spindle, bearings and seals
- Smooth running with reduced bearing load

TIMING GEARS



- External double helical gear for efficient power transmission
- Oil lubricated by internal or external circulation
- Oil cooling if required
- Smooth running

MECHANICAL SEAL



- Seal design acc. to API 682
- Installation in suction area
- Unbalanced or balanced design
- Single acting mechanical seal
- Double acting mechanical seal with seal supply system acc. to API

BEARINGS



- Self-aligning roller bearings on DE and NDE side
- Oil lubricated bearings (and gear) as an API 676 demand for better lubrication of the shaft seals
- External lube oil cooler and systems for special applications possible

INSTALLATION / DRIVE

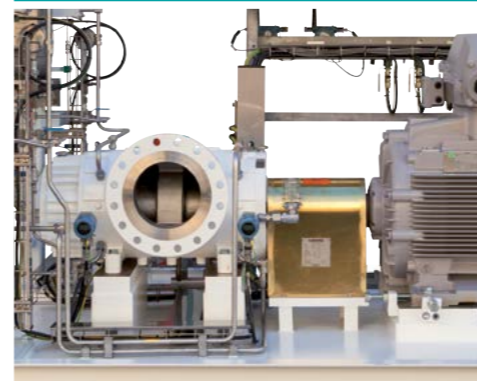

- Delivery of complete skids incl.:
- Common baseplate
 - Electric motors, hydraulic motors or combustion engines
 - Flexible spacer type couplings
 - Variable speed drive
 - Instrumentation

DESIGN AND OPERATION L4 PUMPS

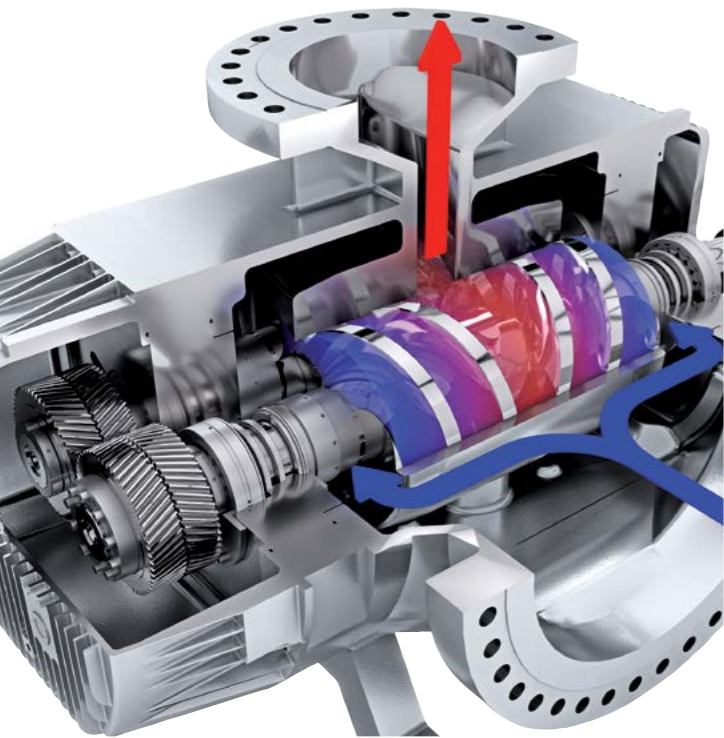

L4 Pumps are selfpriming screw pumps with two screws in double volute and hydraulically balanced design. The drive torque is transmitted from the double helix drive screw to the likewise double helix idler screw via herringbone gears.

The screws rotate closely meshing but without contact in the spindle bore of the interchangeable pump casing insert. As a result of the special profile geometry sealed cavities are formed which transport the pumped liquid continuously with low shear and without turbulences from both suction chambers axially to the discharge chamber.

For optimum strength and low shaft deflection both drive screw and idler screw are manufactured from single piece bar stock.

DISCHARGE PRESSURE AND FLOW RATE

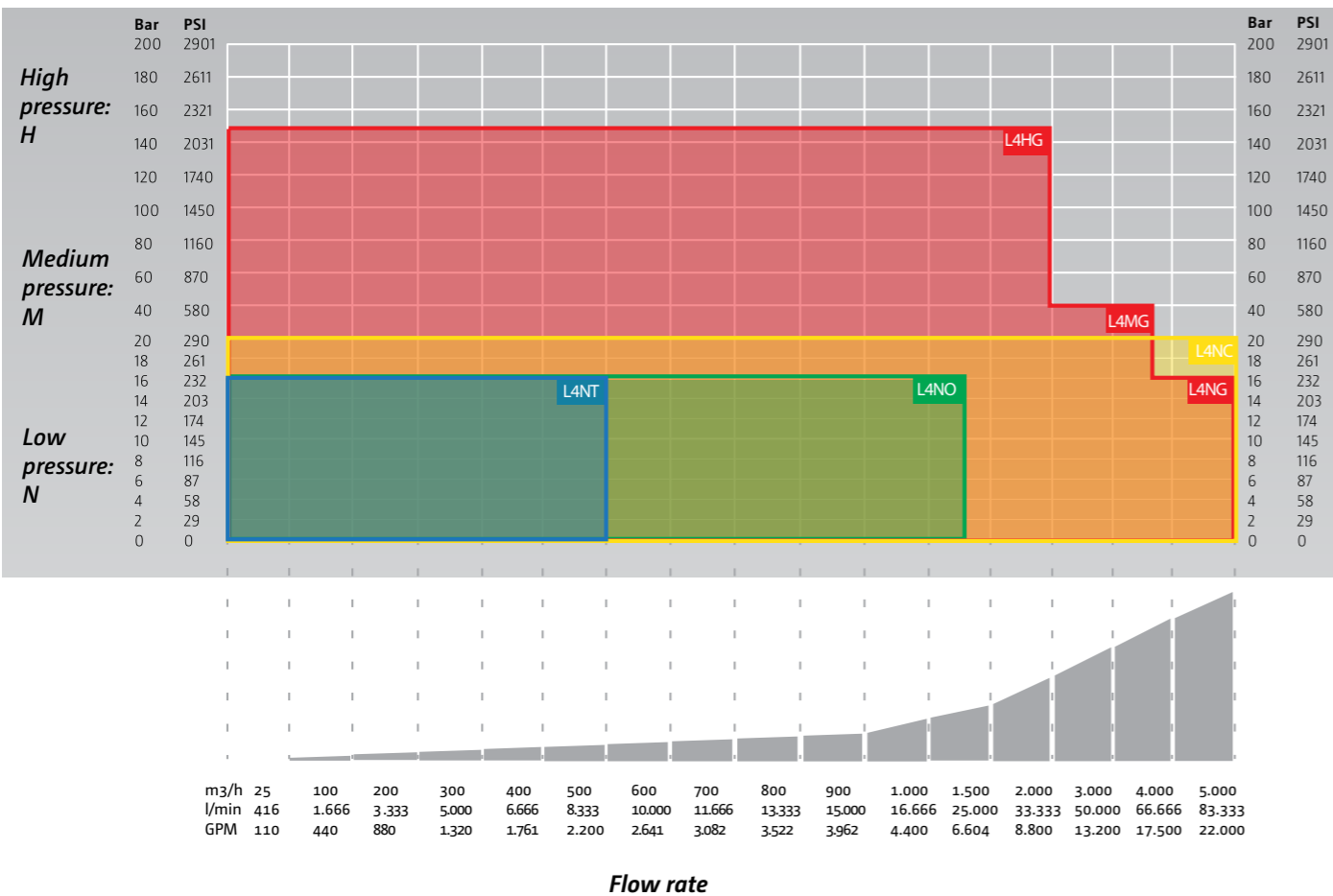

L4 PUMPS TYPE CODE & DESIGN

Pump type			Pump size				Options design code								Seal															
Leistritz	No. of spindles	Pressure ranges	Design				OD Drive screw				Bearing	Mounting		Heating	Mount. flange		Inlet - outlet		Relief valve		Shaft sealing									
			Low pressure	Medium pressure	High pressure	Pump casing	Compact design	Without insert	Semi submersible	Roller bearing external		Mounting foot	Flange mounted		Mounting pedestal	Without heating	Heat chamber or heating foot	Heating jacket	Mounting flange: small	Mounting flange: large	Immersion tube	Inline	Staggered	Side in top out	Without valve	Top mounted valve - flanged	Integrated valve	Shaft sealing: mechanical seal	Shaft sealing: steam quench	Packing
L	4	N M H	G	C	O	T	-	-	-	-	-	A	H	F	S	O	H	M	K	G	T	I	V	R	O	A	I	G	Q	S

L4NG/L4MG/L4HG - modular pump: pages 8-13

Pump type			Pump size				Options design code								Seal																					
L	4	N M H	Design				OD Drive screw				A	Mounting		O	Mount. flange		Inlet - outlet		Relief valve		Shaft sealing															
			G	C	O	T	116	135	150	176		220	260		310	345	405	450	H	F	S	O	H	M	K	G	T	I	V	R	O	A	I	G	Q	S
L	4	N M H	G	C	O	T	-	106	126	140	164	200	240	280	330	365	410	A	H	F	S	O	H	M	K	G	T	I	V	R	O	A	I	G	Q	S
L	4	N M H	G	C	O	T	-	100	116	128	150	186	220	256	295	330	365	A	H	F	S	O	H	M	K	G	T	I	V	R	O	A	I	G	Q	S

L4NC - compact design pump: pages 14-15

Pump type			Pump size				Options design code								Seal																		
L	4	N M H	Design				OD Drive screw				A	Mounting		O	Mount. flange		Inlet - outlet		Relief valve		Shaft sealing												
			G	C	O	T <td>135</td> <td>172</td> <td>230</td> <td>295</td> <td>345</td> <td>395</td> <td>450</td> <td>H</td> <td>F</td> <td>S</td> <td>O</td> <td>H</td> <td>M</td> <td>K</td> <td>G</td> <td>T</td> <td>I</td> <td>V</td> <td>R</td> <td>O</td> <td>A</td> <td>I</td> <td>G</td> <td>Q</td> <td>S</td>	135	172	230	295		345	395		450	H	F	S	O	H	M	K	G	T	I	V	R	O	A	I	G	Q	S
L	4	N M H	G	C	O	T	-	135	172	230	295	345	395	450	A	H	F	S	O	H	M	K	G	T	I	V	R	O	A	I	G	Q	S

L4NO - cargo pump: page 16

Pump type			Pump size				Options design code								Seal																
L	4	N M H	Design				OD Drive screw				A	Mounting		O	Mount. flange		Inlet - outlet		Relief valve		Shaft sealing										
			G	C	O	T <td>126</td> <td>164</td> <td>230</td> <td>212</td> <td>256</td> <td>H</td> <td>F</td> <td>S</td> <td>O</td> <td>H</td> <td>M</td> <td>K</td> <td>G</td> <td>T</td> <td>I</td> <td>V</td> <td>R</td> <td>O</td> <td>A</td> <td>I</td> <td>G</td> <td>Q</td> <td>S</td>	126	164	230	212		256	H		F	S	O	H	M	K	G	T	I	V	R	O	A	I	G	Q	S
L	4	N M H	G	C	O	T	-	126	164	230	212	256	A	H	F	S	O	H	M	K	G	T	I	V	R	O	A	I	G	Q	S

L4NT - submerged pump: page 17

Pump type			Pump size				Options design code								Seal															
L	4	N M H	Design				OD Drive screw				A	Mounting		O	Mount. flange		Inlet - outlet		Relief valve		Shaft sealing									
			G	C	O	T <td>96</td> <td>140</td> <td>186</td> <td>240</td> <td>H</td> <td>F</td> <td>S</td> <td>O</td> <td>H</td> <td>M</td> <td>K</td> <td>G</td> <td>T</td> <td>I</td> <td>V</td> <td>R</td> <td>O</td> <td>A</td> <td>I</td> <td>G</td> <td>Q</td> <td>S</td>	96	140	186	240		H	F		S	O	H	M	K	G	T	I	V	R	O	A	I	G	Q	S
L	4	N M H	G	C	O	T	-	96	140	186	240	A	H	F	S	O	H	M	K	G	T	I	V	R	O	A	I	G	Q	S

L4NG, L4MG, L4HG MODULAR PUMP

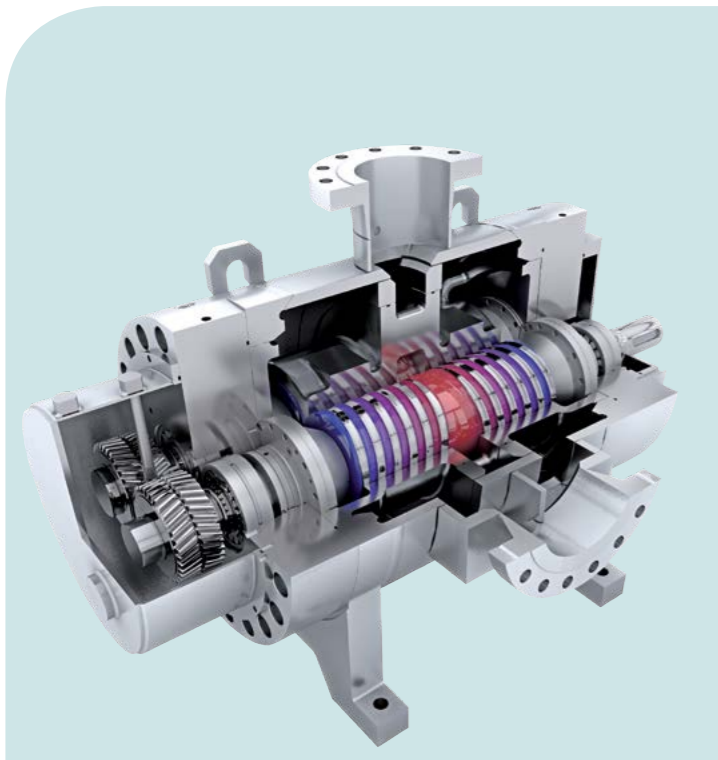

GENERAL USE

Leistriz Screw Pumps L4NG/MG/HG are self-priming rotary positive displacement pumps for pressure ranges of 16 bar (232 psi), 40 bar (580 psi) and 150 bar (2175 psi) suitable for the transport of lubricating and non-lubricating, low and high viscous liquids with abrasive particles.

USER ADVANTAGES

- Maximum allowable rotor deflection limited to 50% of radial clearance between rotor housing and rotor → highest process safety
- Interchangeable liner → easy maintenance, low costs
- Special rotor design available → Minimized pulsation → Optimized NPSHR
- Low axial flow velocity → excellent priming
- Suitable for dry running → maximized process safety

MODULAR SYSTEM

The components of the low, medium and high pressure pumps are produced as a modular system. Pump casings, bearing covers, bearings, mechanical seals, mechanical seal installation parts and the timing gears are interchangeable among pumps of different sizes.

For installations with different pump sizes and designs the modular system for the Leistriz L4 series twin screw pumps permits simple and economical keeping of a spare parts inventory.

The modular system covers both liquid and multiphase pumps of the Leistriz L4 series.

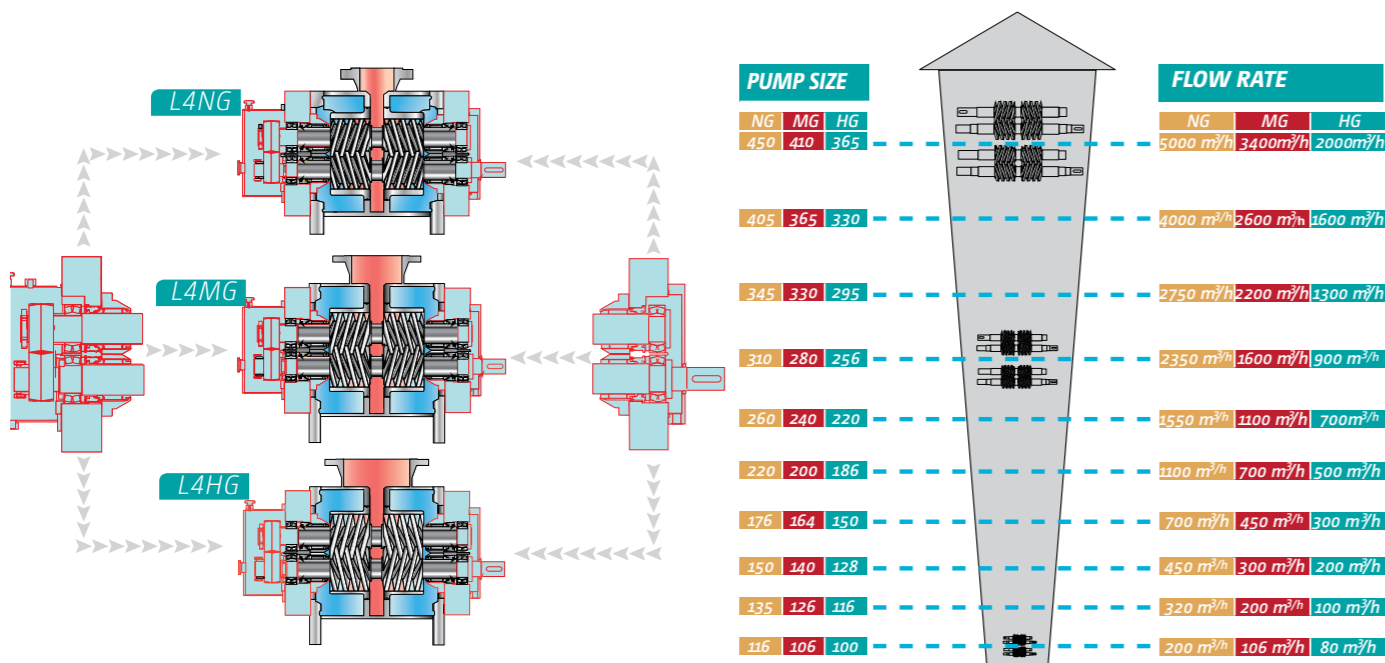

PERFORMANCE CHARACTERISTICS

L4NG - OPERATING CONDITIONS

Flow rate max.	5,000 m³/h 22,000 GPM
Differential pressure max.	16 bar 232 psi
Viscosity max.	150,000 cSt
Temperature max.	350°C 662°F

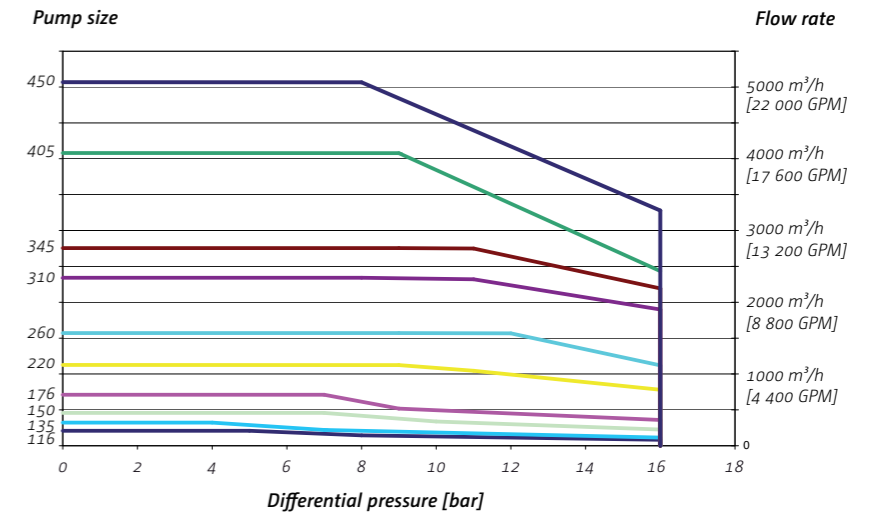

L4MG - OPERATING CONDITIONS

Flow rate max.	3,900 m³/h 17,160 GPM
Differential pressure max.	40 bar 580 psi
Viscosity max.	150,000 cSt
Temperature max.	350°C 662°F

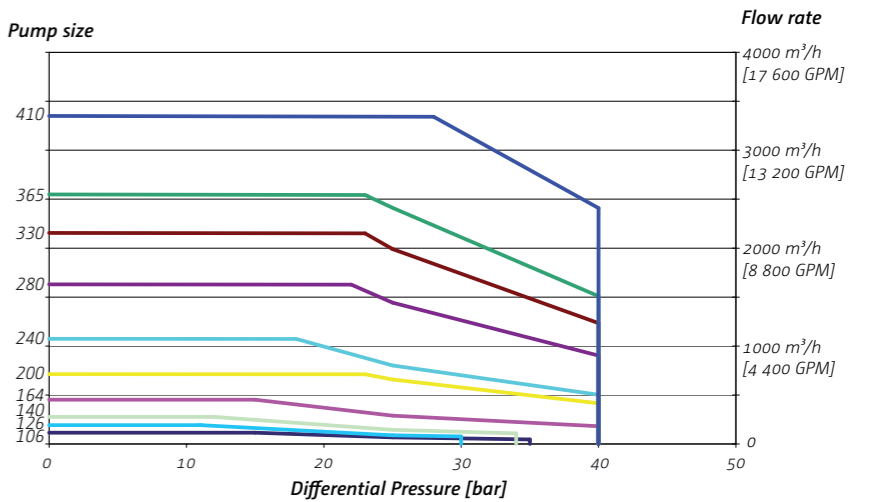

L4HG - OPERATING CONDITIONS

Flow rate max.	2,000 m³/h 8,800 GPM
Differential pressure max.	150 bar 2,175 psi
Viscosity max.	150,000 cSt
Temperature max.	350°C 662°F

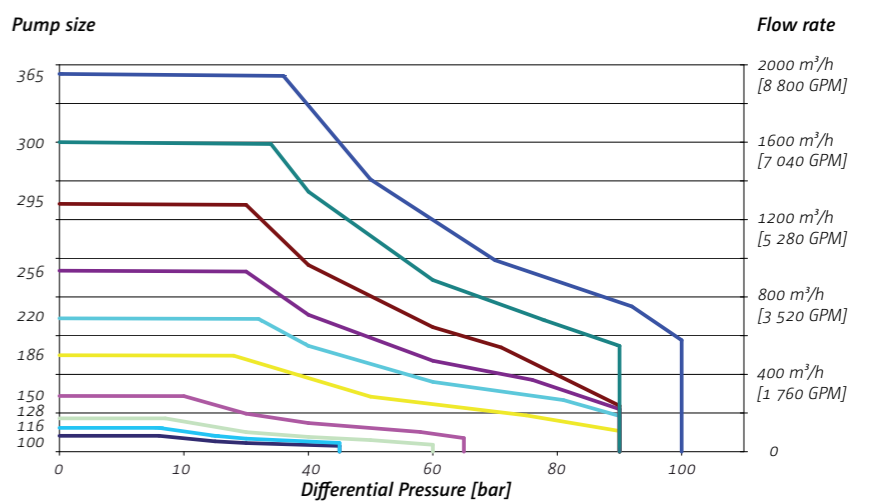



L4NG, L4MG, L4HG APPLICATIONS

APPLICATIONS



➤ Oil & Gas
pipeline pumps · pipeline start-up pumps · produced water pumps · pumps for chemical injection · pumps for upstream slop and drain systems.



➤ Tank Storage
loading/unloading pumps · circulation pumps · transfer pumps · stripping pumps · cargo pumps · tank cleaning pumps



➤ Chemical and Petrochemical Industry
circulation pumps · transfer pumps · stripping pumps · export pumps



➤ Power Generation and Fuel Oil Systems
unloading pumps · transfer pumps.



➤ Shipbuilding
loading/unloading pumps · transfer pumps

TECHNICAL INSTALLATIONS

OIL & GAS INDUSTRY



Used as:
➤ Pipeline booster pumps
Pumped liquid:
➤ Crude oil
Flow rate:
➤ Q = 180 m³/h [793 GPM]
Differential pressure:
➤ ΔP = 60 bar [870 psi]

TANK STORAGE



Used in:
➤ Tank storage in Singapore
Pumped liquid:
➤ Various black and white products
Flow rate:
➤ Q = 2,000 m³/h [8,806 GPM]
Differential pressure:
➤ ΔP = 11 bar [160 psi]

CHEMICAL INDUSTRY



Used in:
➤ Chemical plant in the Netherlands
Pumped liquid:
➤ Polymer
Flow rate:
➤ Q = 876 m³/h [3,857 GPM]
Differential pressure:
➤ ΔP = 48 bar [696 psi]

POWER PLANT



Used in:
➤ Fuel oil power plants
Pumped liquid:
➤ Heavy fuel oil
Flow rate:
➤ Q = 876 m³/h [3,857 GPM]
Differential pressure:
➤ ΔP = 48 bar [696 psi]

MULTIPHASE PUMP SYSTEMS



DESIGN AND OPERATION

Leistritz multiphase pumps are rotary positive displacement pumps based on twin screw pump technology and built in accordance with the requirements of API 676. This makes twin screw multiphase pumps particularly suitable for the handling of non-lubricating products with high gas fractions, contaminations and crude oils with low gravity. Leistritz twin screw multiphase pumps are designed to handle untreated well flow with gas fractions (GVF) between 0 and 100 %. In order to maintain a dynamic seal between the screw packages and the pump casing at high GVF rates a small liquid flow must be provided at all times. An external liquid management system for continuous liquid injection guarantees uninterrupted operation with high GVF content and gas slugs and ensures dissipation of the compression heat. The size of the external liquid management system can be adapted to the actual operating conditions.

BENEFITS OF MULTIPHASE TECHNOLOGY

- The entire well flow is handled with one machine
- Low inlet pressures allow extended well life and increased production
- High pressure capability to boost the well flow to remote processing facilities
- Reduction of artificial lift requirements due to low permissible inlet pressure
- Decrease of the production time
- Low shear, non-emulsifying pumping
- Gas handling capability (GVF) up to 100 %
- Elimination of flaring
- Low capital investment costs and quick payback due to production increase
- Low operational and maintenance cost
- Ideal for installation on offshore platforms due to small footprint and low weight

LEISTRITZ SYSTEM SUPPLY

- Leistritz multiphase pump
- Single or double acting mechanical seals
- Customized liquid management system
- Skid type baseplate
- Electric motors / combustion engines / gas or diesel engines
- Flexible all metal coupling with non-sparking coupling guard
- On-skid instrumentation
- On-skid piping with manually or actuator operated block valves, suction filter, check and pressure relief valve
- Lube and seal oil systems
- Variable speed drives
- PLC, low and medium voltage switch gears, MCC, UPS
- Remote control systems
- Container for installation of the multiphase pump skids and the control equipment

TECHNICAL INSTALLATIONS

OFFSHORE ON A WELLHEAD PLATFORM IN THE GULF OF MEXICO



Used as:
 ➤ Multiphase pump
Gas volume fraction:
 ➤ GVF = 97.2 % [3,870 GPM]
Flow rate:
 ➤ Q = 879 m³/h
Differential pressure:
 ➤ ΔP = 17.25 bar [250 psi]

CONTAINERIZED LEISTRITZ MULTIPHASE PUMP IN A PERMAFROST AREA IN KAZAKHSTAN



Used as:
 ➤ Multiphase pump
Gas volume fraction:
 ➤ GVF = 86.6 %
Flow rate:
 ➤ Q = 175 m³/h [770 GPM]
Differential pressure:
 ➤ ΔP = 38 bar [551 psi]

LEISTRITZ MULTIPHASE PUMP INSTALLATION ON AN OIL FIELD IN CENTRAL AFRICA



Used as:
 ➤ Multiphase pump
Gas volume fraction:
 ➤ GVF = 56 %
Flow rate:
 ➤ Q = 395-1,000 m³/h [1,739-4,402 GPM]
Differential pressure:
 ➤ ΔP = 7.3- 56.2 bar [105-915 psi]

LEISTRITZ MULTIPHASE PUMP WITH INSULATION ON A CALIFORNIAN OIL FIELD



Used as:
 ➤ Multiphase pump
Gas volume fraction:
 ➤ GVF = 97 %
Flow rate:
 ➤ Q = 966 m³/h [4,253 GPM]
Differential pressure:
 ➤ ΔP = 14.8 bar [214 psi]

L4NC COMPACT DESIGN PUMP

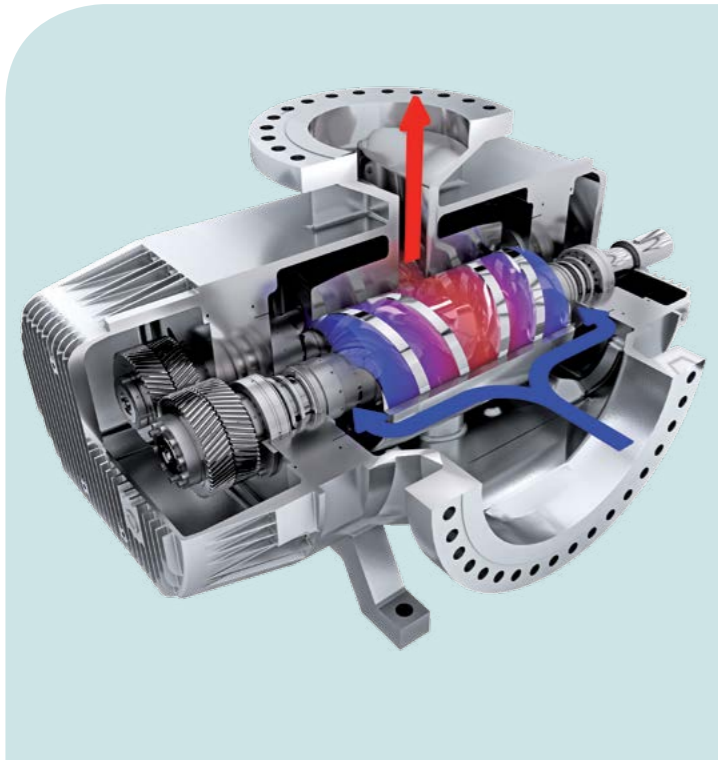

GENERAL USE

The new compact screw pump design for the oil & gas industry!
 With focus on tank farm applications such as transfer, stripping, loading and unloading pumps. Developed for low capital expenditure (CAPEX) combined with highest efficiency and reliability for optimized operational expenditure (OPEX)

USER ADVANTAGES

- Pump casing:**
 - Economic and slim design for reduced weight
- Spindles:**
 - Single bar stock for maximum stiffness
- Timing gears:**
 - External double helical gear for efficient power transmission
- Mechanical seal:**
 - Single acting seals
- Bearings:**
 - Self-aligning roller bearings on DE and NDE side



L4NC - OPERATING CONDITIONS AND PERFORMANCE CHARACTERISTICS

Flow rate max.	5,000 m ³ /h 22,000 GPM
Differential pressure max.	20 bar 290 psi
Viscosity max.	10,000 cSt
Temperature max.	100 °C 212 °F
Casing design pressure	25 bar 362 psi

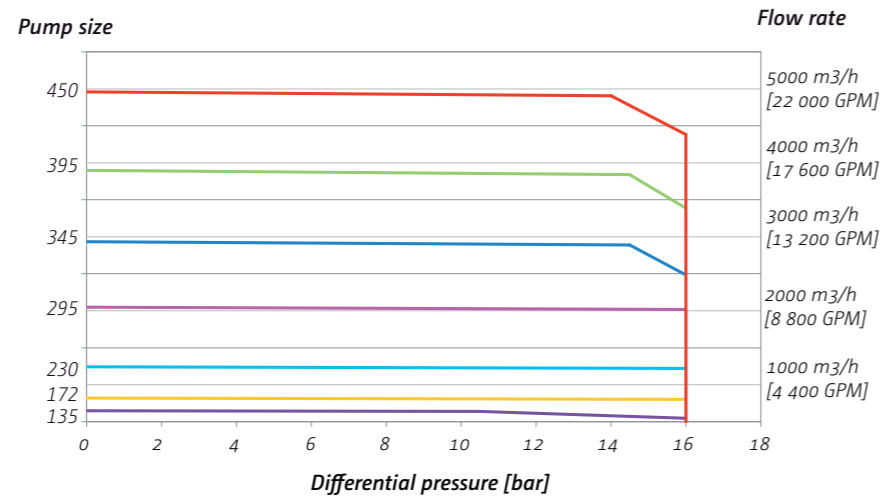

APPLICATIONS

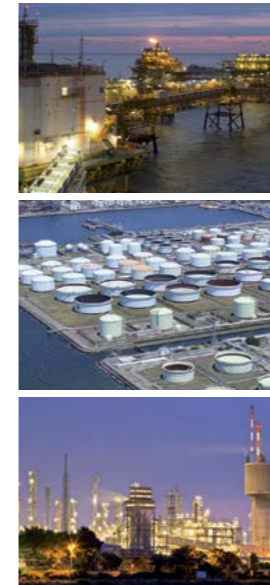

- Oil & Gas
 pipeline pump · pipeline start-up pump · produced water pump · chemical injection pump
- Tank Storage
 loading/unloading pump · circulation pump · transfer pump · stripping pump · cargo pump · tank cleaning pump
- Chemical and Petrochemical Industry
 transfer pump

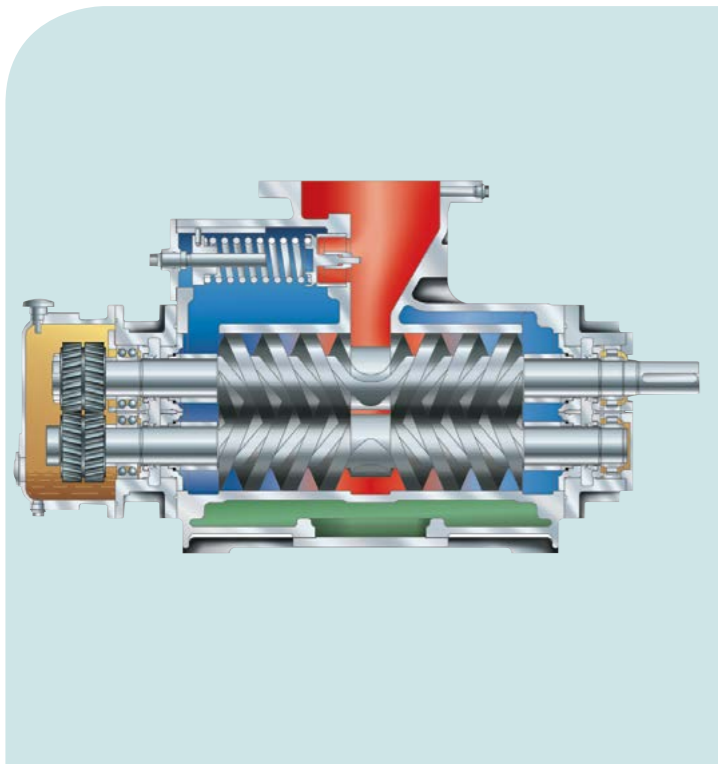

L4NO CARGO PUMP



GENERAL USE

The Leistriz screw pump series L4NO is a self-priming positive displacement pump for a pressure range up to max. 16 bar, suitable for transporting abrasive and non-abrasive, lubricating and non lubricating fluids.

APPLICATIONS

-  **Power Generation**
transfer pump · supply pump · waste oil pump
-  **Shipbuilding**
cargo pump · unloading pump · transfer pump
-  **Chemical and Petrochemical Industry**
transfer pump

POWER PLANT (COMBINED CYCLE)



- Used as:**
- Unloading pump
- Pumped liquid:**
- Light fuel oil
- Flow rate:**
- Q = 156 m³/h [686 GPM]
- Differential pressure:**
- ΔP = 5 bar [72 PSI]

OPERATING CONDITIONS AND PERFORMANCE CHARACTERISTICS

Flow rate max.	1,250 m ³ /h 5,503 GPM
Differential pressure max.	16 bar 232 psi
Viscosity max.	15,000 mm ² /s
Temperature max.	180 °C 356 °F

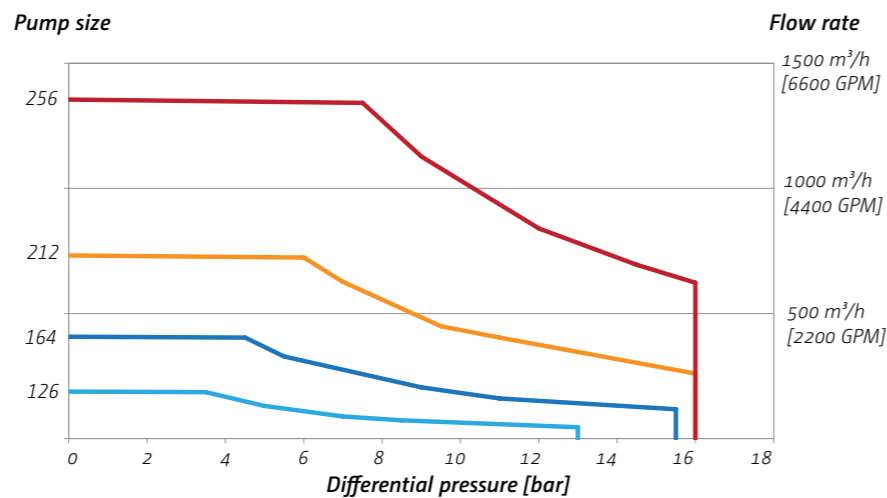

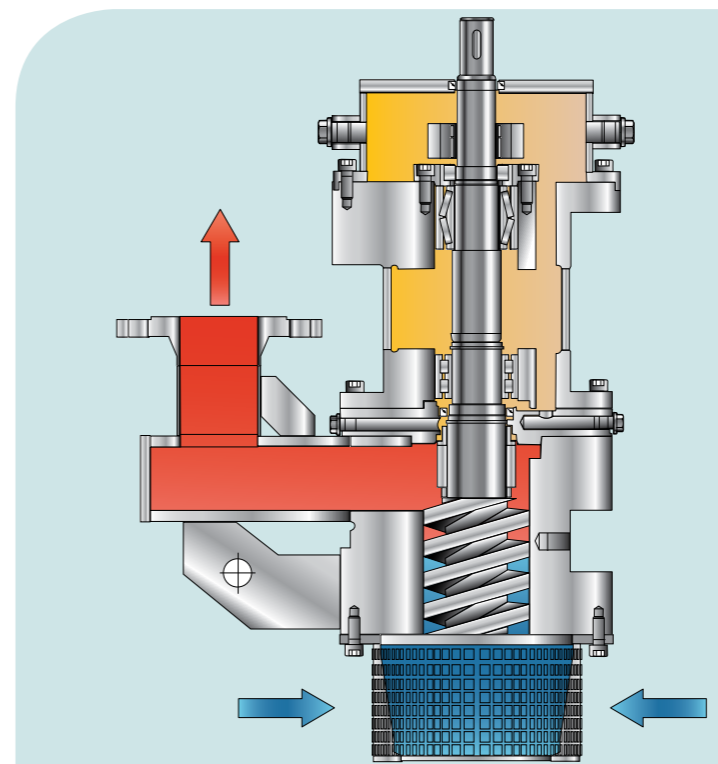

L4NT SUBMERGED PUMP



GENERAL USE

Leistriz screw pumps of the series L4NT are submerged rotary positive displacement pumps for pumping corrosive liquids, or liquids with solid content, liquids containing gases and liquids of high and low viscosity.

APPLICATIONS

-  **Oil and Gas Industry**
closed and open drain pump · transfer pump · slop pump
-  **Shipbuilding**
unloading pump
-  **Chemical and Petrochemical Industry**
transfer pump · circulation pump

OIL & GAS INDUSTRY



- Used as:**
- Slops & drains pump
- Pumped liquid:**
- Mixtures of water, hydrocarbons and solids
- Flow rate:**
- Q = 145 m³/h [638 GPM]
- Differential pressure:**
- ΔP = 3 bar [43 PSI]

L4NT - OPERATING CONDITIONS AND PERFORMANCE CHARACTERISTICS

Flow rate max.	500 m ³ /h 2,200 GPM
Differential pressure max.	16 bar 225 psi
Viscosity max.	100,000 cSt
Temperature max.	150°C 212°F
Installation depth max.	10 m 32.8 ft

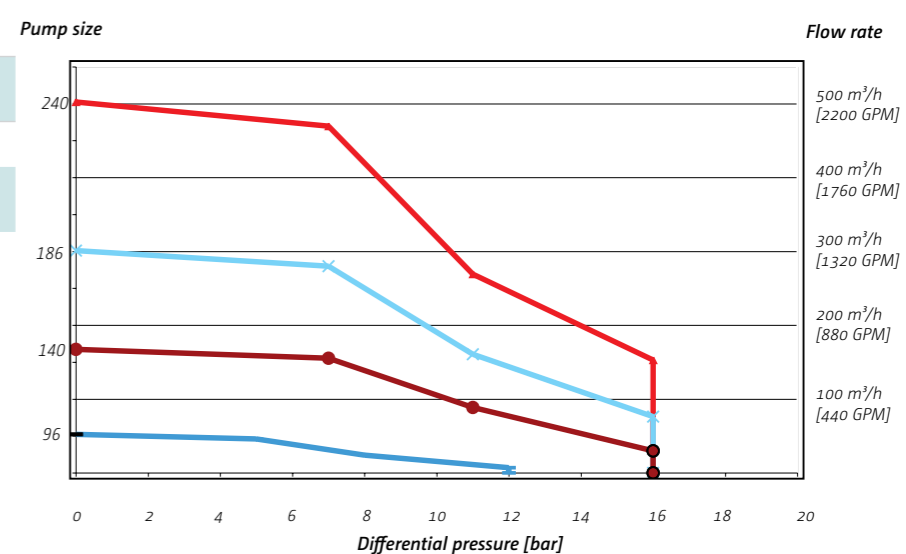

MANUFACTURING KNOW-HOW

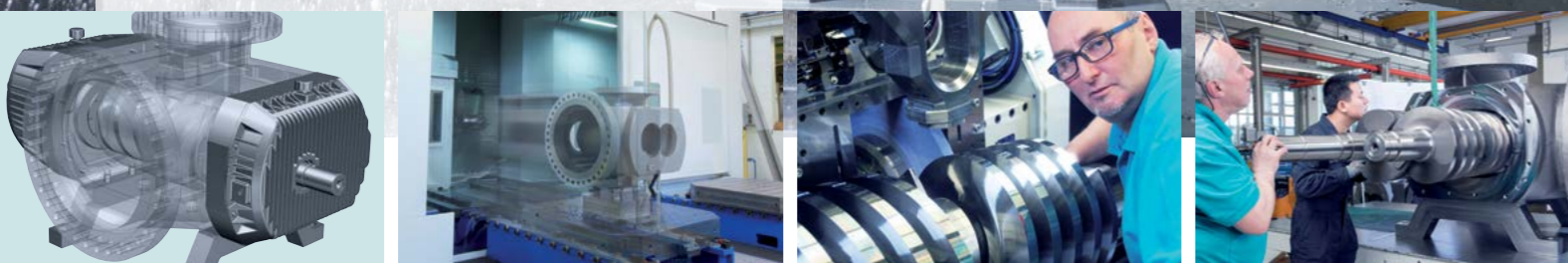







» Leistriz pumps are manufactured with expertise and passion. «

Rising demands on pump manufacturers regarding wear protection, service life or flow rate require the use of state-of-the-art machine technology and process chains that are ideally coordinated with one another. These are the prerequisites to facilitate the high-quality manufacturing of pump components.

To accomplish this high standard, we produce the screws and housings, i.e. the core elements of the Leistriz pumps, ourselves in Germany - under the aspect of the ultimate precision vertical integration. This is particularly due to the symbiosis of the various products of the Leistriz Group in the form of superior materials know-how and in-house metal processing technologies, such as whirling. In addition to our numerous machines, it is particularly our team that convinces our customers with its well-founded expertise and extensive manufacturing know-how.

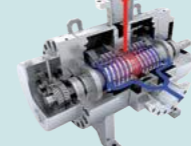

PUMP RANGE

SERIES	USE FOR	PUMP TYPE	PERFORMANCE DATA			
			Flow rate	Pressure	Viscosity	Temperature
L2N	Low pressure duty, suitable for transport of slightly abrasive and corrosive, high or low viscous fluids with poor or good lubricity.		900 m ³ /h 3,960 GPM	16 bar 232 psi	100,000 cSt	280°C 536°F
L3N	Low pressure duty, suitable for transport of non-abrasive lubricating fluids.		700 m ³ /h 3,100 GPM	16 bar 232 psi	15,000 cSt	180°C 356°F
L3M	Medium pressure duty, suitable for transport of non-abrasive lubricating fluids.		300 m ³ /h 1,320 GPM	80 bar 1,160 psi	10,000 cSt	280°C 536°F
L3H L3V L3U	High and ultra high pressure duty, suitable for transport of non-abrasive, slightly abrasive and corrosive, high or low viscous fluids with poor or good lubricity.		200 m ³ /h 880 GPM	280 bar 4,060 psi	10,000 cSt	280°C 536°F
L4N L4M L4H	Low, medium and high pressure duty, suitable for transport of abrasive/non-abrasive, corrosive/non-corrosive, lubricating/non-lubricating, high or low viscous fluids.		5,000 m ³ /h 22,000 GPM	150 bar 2,175 psi	150,000 cSt	350°C 662°F
L5N	Low pressure duty, suitable for transport of slightly abrasive and corrosive, high or low viscous fluids with poor or good lubricity.		1,700 m ³ /h 7,500 GPM	10 bar 145 psi	100,000 cSt	280°C 536°F

This list offers a general overview of the standard pump range by Leistriz. Various options and systems are individually configured according to customer requirements and tested on our test bench (drive power up to 4 MW) in Nuremberg.

PUMP TECHNOLOGY

Available for you all over the world

